



DATRON HIGH-SPEED MILLING TOOLS

Precision. Performance. For aluminium and other materials...



DATRON

CNC milling tools

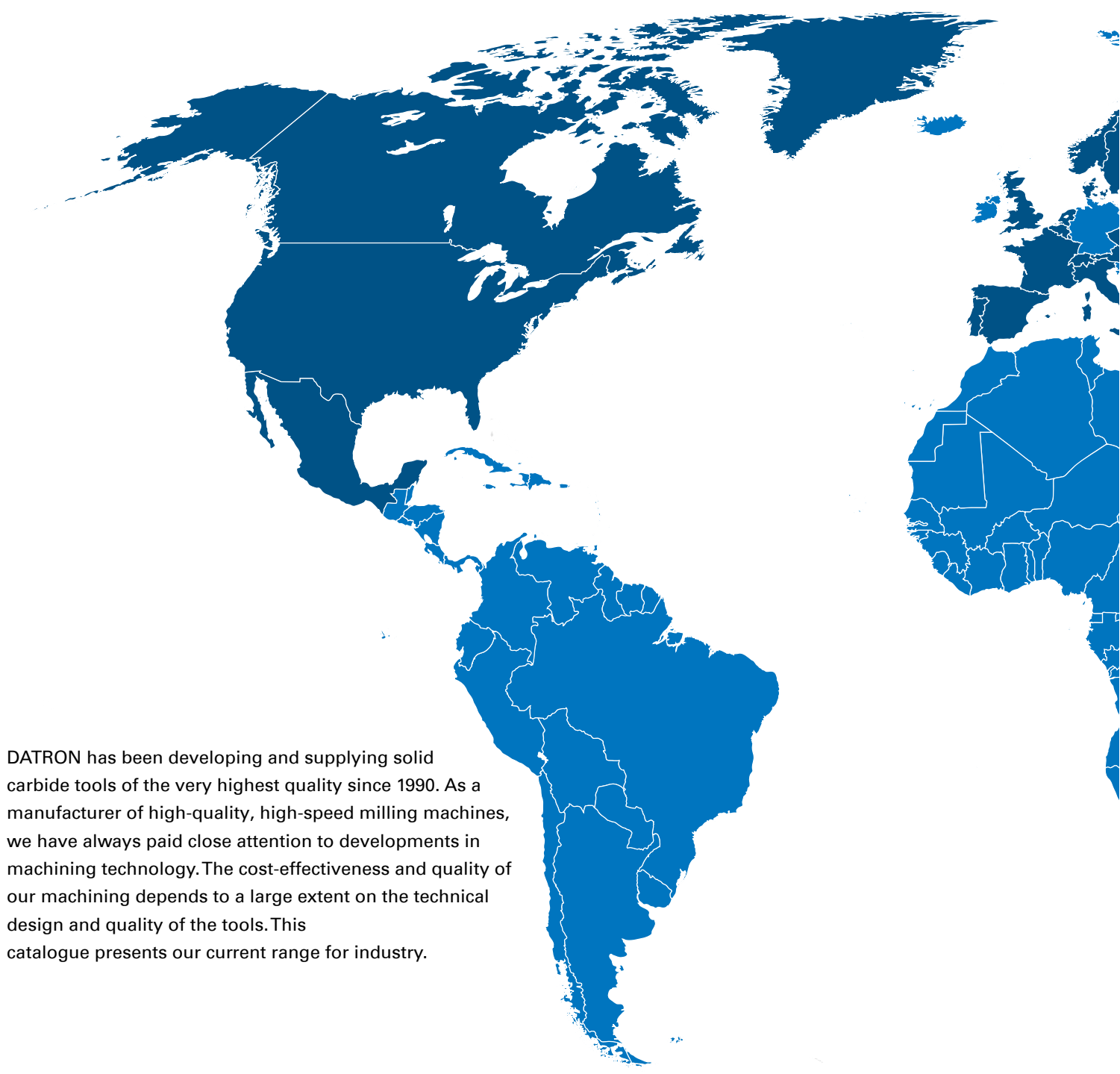

DATRON has been developing and supplying solid carbide tools of the very highest quality since 1990. As a manufacturer of high-quality, high-speed milling machines, we have always paid close attention to developments in machining technology. The cost-effectiveness and quality of our machining depends to a large extent on the technical design and quality of the tools. This catalogue presents our current range for industry.

DATRON is present around the world!

We work with representatives around the world to market our milling tools to guarantee fast delivery for you.

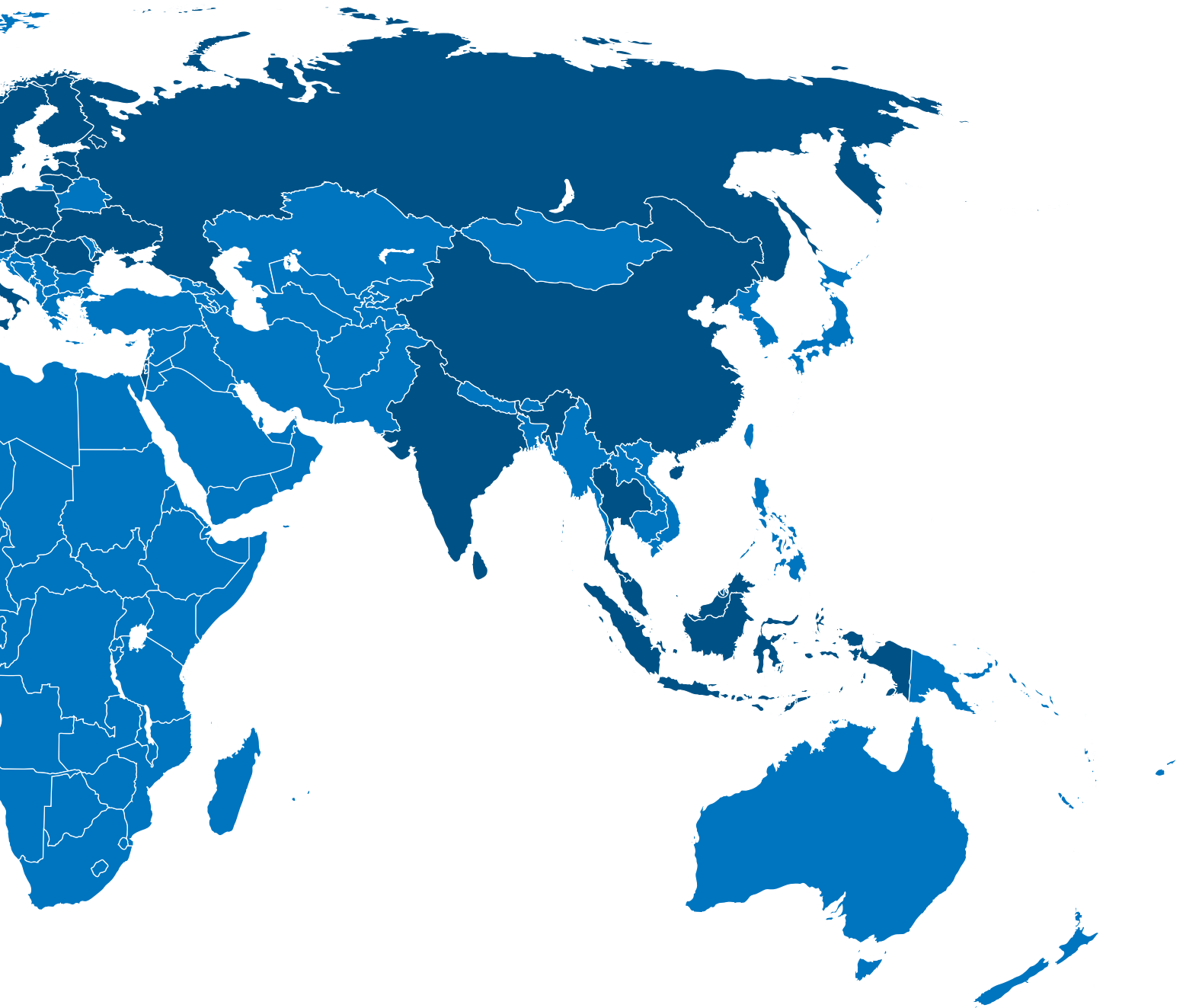

Contents

TOOLS

MATERIAL

Aluminium Copper Bronze Brass Steel Plastic Wood Foams

SHANK MILL



	Aluminium	Copper	Bronze	Brass	Steel	Plastic	Wood	Foams
Single flute end mill 4-IN-1	++	+	+	+		++	++	
Single flute end mill balanced	++	+	+	+		++	++	
Single flute end mill	++	+	+	+		++	++	
Single flute end mill with toric cut	++	+	+	+		++	++	
Single flute end mill with coating (ALCRONA)	+		++	+			+	
Single flute end mill with polished flute for acrylic glass						++		
Single flute end mill left spiral, right cutting	++		+	+		++	++	
CrossCutter	++	+	+	+		++	++	
Double flute end mill	++	++	+	++		++	+	
Double flute end mill with toric cut	++	++	+	++		++	+	
Double flute end mill, contour cutter	++			++		++	+	
Double flute end mill HSC+	+	+		+		++	+	
Double flute end mill HSC Fire	++			++		+	+	
Double flute end mill with internal cooling	++	++	+	++		++	++	
Double flute end mill for machining steel					++			
Triple flute end mill, roughing cutter for copper		++						
Triple flute end mill, finishing cutter for copper		++						
Triple flute end mill with toric cut	+	+		+			++	
Triple flute end mill for foam								++
Triple flute end mill with coating (X.CEED)					++			
Four flute end mill with coating (ALCRONA)					++			
Micro-toothed end mill								
Micro-toothed end mill with coating (X.CEED/diamond)								
Diamond milling tool for CRP/GRP								

FACE MILLING TOOL



Single flute end mill, stepped	++	+		++		+	+	
Double flute end mill, stepped	++	+		++		+	+	
Double flute end mill, stepped and edge radius	++	+		++		+	+	
Double flute end mill, stepped with edge radius and polished flute for acrylic glass						++		
Face milling tool/monoblock	++	++	+	++	++	++	+	

BALL NOSE END MILL

















Ball nose end mill, one flute	++		+	+		++	++	
Ball nose end mill, one flute and polished for acrylic glass						++		
Ball nose end mill, two flutes	++	++	++	++		++	++	
Ball nose end mill, two flutes with toric cut	++	++	++	++		++	++	
Ball nose end mill, two flutes with coating (ALCRONA)					++			
Ball nose end mill, four flutes with coating (ALCRONA)					++			

TORIC END MILL



Double flute end mill with edge radius	++	+		++		+	+	
Double flute end mill with edge radius and coating (Triple-Cut)	++	+		++		+	+	
Four flute end mill with edge radius and coating (X.CEED)					++			
Four flute end mill with double radius and coating (X.CEED)					++			

GRP/CRP	Acrylic glass	GEOMETRY										Page	
		Number of flutes	D1 (mm)	D2 (mm)	D3 (mm)	L1 (mm)	L2 (mm)	L3 (mm)	R (mm)	Thread size	W (°)		BS
		1	3.0 - 12.0	6.0 - 12.0	2.8 - 11.0	40.0 - 95.0	5.0 - 36.0	13.0 - 61.0	-	-	-	-	12
		1	5.0 - 12.0	6.0 - 12.0	4.8 - 11.0	50.0 - 85.0	8.5 - 32.5	13.5 - 52.0	-	-	-	-	14
		1	0.3 - 10.0	3.0 - 10.0	-	38.0 - 100.0	1.0 - 40.0	-	-	-	-	-	16
		1	1.0 - 6.0	6.0	0.9 - 5.3	50.0 - 60.0	4.0 - 14.0	7.0 - 30.0	-	-	-	-	18
+		1	2.0 - 6.0	6.0	-	50.0 - 58.0	5.0 - 22.0	-	-	-	-	x	19
	++	1	1.0 - 10.0	6.0 - 10.0	-	50.0 - 75.0	4.0 - 32.0	-	-	-	-	-	20
		1	1.5 - 6.0	6.0	-	50.0 - 60.0	7.0 - 20.0	-	-	-	-	-	21
		1	6.0 - 12.0	6.0 - 12.0	-	58.0 - 90.0	21.0 - 51.0	-	-	-	-	-	22
		2	0.1 - 12.0	3.0 - 12.0	5.7 - 11.7	38.0 - 100.0	0.2 - 40.0	22.0 - 35.0	-	-	-	-	24
		2	0.5 - 6.0	3.0 - 6.0	0.45 - 5.7	38.0 - 60.0	0.75 - 20.0	4.0 - 33.0	-	-	-	-	26
		2	3.0 - 12.0	6.0 - 12.0	-	57.0 - 70.0	8.0 - 25.0	-	-	-	-	-	27
		2	1.5 - 6.0	3.0 - 6.0	-	40.0 - 58.0	4.0 - 12.0	-	-	-	-	-	28
		2	6.0 - 10.0	6.0 - 10.0	-	50.0 - 70.0	12.0 - 32.0	-	-	-	-	-	29
		2	6.0 - 12.0	6.0 - 12.0	5.6 - 11.2	60.0 - 80.0	14.0 - 32.0	32.0 - 48.0	-	-	-	-	30
		2	0.9 - 3.0	3.0	-	38.0	1.1 - 7.0	-	-	-	-	-	31
		3	3.0 - 10.0	6.0 - 10.0	-	50.0 - 60.0	6.0 - 22.0	-	-	-	-	-	32
		3	1.0 - 8.0	6.0 - 8.0	-	50.0	2.2 - 16.0	-	-	-	-	-	33
		3	3.0 - 12.0	6.0 - 12.0	2.8 - 11.8	58.0 - 83.0	8.0 - 26.0	12.0 - 38.0	-	-	-	-	34
		3	3.0 - 10.0	6.0 - 10.0	2.7 - 9.5	50.0 - 115.0	6.0 - 52.0	22.0 - 82.0	-	-	-	-	35
		3	1.75 - 6.0	3.0 - 6.0	-	40.0 - 50.0	3.0 - 10.0	-	-	-	-	x	36
		4	2.0 - 12.0	6.0 - 12.0	-	50.0 - 100.0	7.0 - 45.0	-	-	-	-	x	37
++		8	0.6 - 3.0	3.0 - 3,175	-	38.0	3.0 - 12.0	-	-	-	-	-	38
++		8	0.6 - 6.0	3.0 - 6.0	-	38.0 - 50.0	3.0 - 22.0	-	-	-	-	x	39
++		1-2	3.0 - 10.0	6.0 - 10.0	2.8 - 9.2	50.0 - 60.0	5.0 - 12.0	6.0 - 17.0	-	-	-	x	40
		1	14.0 - 24.0	8.0 - 12.0	-	45.0 - 60.0	5.0 - 8.5	-	-	-	-	-	42
		2	8.0 - 20.0	6.0 - 12.0	-	50.0 - 82.0	6.0 - 10.0	-	-	-	-	-	43
		2	12.0 - 20.0	6.0 - 8.0	-	50.0	6.0 - 8.0	-	0.5	-	-	-	44
	++	2	10.0 - 16.0	6.0 - 8.0	-	50.0	6.0	-	1.0	-	-	-	45
		2	20.0 - 24.0	-	18.5 - 22.5	-	10.0	38.0 - 63.0	0.8	-	-	-	46
		1	1.0 - 10.0	3.0 - 10.0	-	40.0 - 60.0	4.0 - 20.0	-	0.5 - 5.0	-	-	-	48
	++	1	1.0 - 6.0	6.0	0.9 - 5.8	50.0	4.0 - 14.0	12.0 - 22.0	0.5 - 2.5	-	-	-	49
		2	0.3 - 8.0	3.0 - 8.0	-	39.0 - 50.0	0.5 - 12.0	-	0.15 - 4.0	-	-	-	50
		2	0.4 - 12.0	3.0 - 12.0	0.35 - 11.7	39.0 - 100.0	0.6 - 20.0	2.0 - 40.0	0.2 - 6.0	-	-	-	51
		2	0.4 - 3.0	3.0	-	38.0 - 39.0	1.2 - 6.0	-	0.2 - 1.25	-	-	-	52
		4	2.0 - 12.0	6.0 - 12.0	-	57.0 - 100.0	6.0 - 45.0	-	1.0 - 6.0	-	-	-	53
		2	6.0 - 8.0	6.0 - 8.0	5.8 - 7.8	50.0 - 60.0	6.0 - 12.0	21.0 - 23.0	0.2 - 1.0	-	-	-	56
		2	3.0 - 10.0	3.0 - 10.0	2.7 - 9.2	50.0 - 72.0	4.0 - 11.0	14.0 - 32.0	0.3 - 1.0	-	-	x	57
		4	2.0 - 10.0	6.0 - 10.0	1.8 - 9.2	50.0 - 72.0	4.0 - 11.0	12.0 - 32.0	0.2 - 1.0	-	-	x	58
		4	3.0 - 6.0	6.0	-	50.0	1.0	-	0.8	-	-	x	59

TOOLS	MATERIAL							
	Aluminium	Copper	Bronze	Brass	Steel	Plastic	Wood	Foams
CHAMFER MILL								
	Chamfer mill	++		+	+	++	++	
	Chamfer mill for acrylic glass					++		
	Chamfer mill for foam							++
	Milling countersink tool	++		+	+	++	++	
	V-slot milling tool	++		+	+	++	++	
DRILL								
	Drill, 3mm shank	++	++	++	++	+	++	+
	Drill, 1/8" shank	++	++	++	++	+	++	+
	Drill, 6mm shank	++	++	++	++		++	+
REAMER								
	Reamer	++	+	+	+			
THREAD MILLING CUTTER								
	Thread whirler	++	++	++	++		++	+
	Multi-thread whirler	++	++	++	++	+	++	+
	Milling thread mill	++	+		++		++	+
	Thread milling cutter	++			++		++	
EXTERNAL RADIUS END MILL								
	External radius end mill	++		+	+		++	++
	External radius end mill, polished for acrylic glass						++	
	Deburring miller, two flutes					++		
STANDARD ENGRAVING TOOL								
	Standard engraving tool	++	++	++	++		++	+
	Standard engraving tool, balanced	++	++	++	++		++	+
	Standard engraving tool for machining steel					++		
	Standard engraving tool for hard machining with coating (ALCRONA)			+		++		
T-SLOTTING MILL								
	T-slotting mill	++		+	+		++	++
CUTTING DIAMOND								
	Cutting diamond	++	++	++	++		+	+
SWALLOW-TAIL MILL								
	Swallow-tail mill	++		+	+		++	++

Why choose a single-flute end mill?	8
List of abbreviations	10
HSK clamping system	
Polygon clamping technique	102
HSK-E 25 & HSK-E 32 polygon clamping chuck	103
DATRON clamping system for polygon clamping chuck	104
DATRON reducing inserts for polygon clamping chuck	104

DATRON DR 16 collet chuck holder for HSK-E 32	105
DATRON mounting accessories for DR 16 collet chuck holder	105
Direct clamping system	
Adapter collets for direct shank clamping systems	106
DATRON insertion tools and limit stop rings	106
Consumable material	
VacuCard	108

GRP/CRP	Acrylic glass	GEOMETRY									Thread size	W (°)	BS	Page
		Number of flutes	D1 (mm)	D2 (mm)	D3 (mm)	L1 (mm)	L2 (mm)	L3 (mm)	R (mm)					
		2 - 4	3.0 - 14.0	3.0 - 10.0	-	40.0 - 50.0	1.1 - 8.2	-	-	-	40 - 140	-	62	
	+	3/6	0.1 - 4.0	6.0	6.0 - 16.0	50.0	3.0 - 6.0	-	-	-	90	-	63	
		3	4.0	6.0	10.0 - 16.0	50.0	3.0 - 6.0	-	-	-	90	-	64	
		1	2.0 - 5.0	6.0	-	50.0	1.0 - 5.0	-	-	-	90	-	65	
		2	5.0 - 8.0	6.0 - 10.0	-	50.0 - 70.0	10.0 - 16.0	-	-	-	60 - 120	-	66	
		2	0.15 - 6.5	3.0	-	38.0	2.0 - 12.0	-	-	-	130	-	68	
		2	0.15 - 6.5	3175	-	38.0	1.0 - 12.0	-	-	-	130 - 165	-	70	
		2	3.0 - 6.0	6.0	-	50.0 - 60.0	21.0 - 31.0	-	-	-	130	-	72	
		3	3.0 - 12.0	6.0 - 12.0	2.5 - 10.0	50.0 - 105.0	6.0 - 36.0	10.0 - 71.0	-	-	-	-	76	
	+	2/4	0.72 - 8.4	3.0 - 10.0	0.32 - 6.35	40.0 - 66.0	0.13 - 0.69	3.0 - 26.0	-	M1 - M12 PG7 - PG48 Whitworth < 1/2"	60	-	80	
	+	4	0.8 - 8.0	3.0 - 6.0	0.49 - 3.0	40.0 - 60.0	0.09 - 1.55	3.0 - 30.0	-	M1 - M10 PG7 - PG48 Whitworth < 1/2"	55 - 80	-	81	
		3	2.0 - 5.6	3.0 - 6.0	1.5 - 5.4	40.0 - 50.0	1.0 - 2.0	8.5 - 12.0	-	M2.5 - M16 PG7 - PG48	60 - 80	-	82	
		N.S.	2.3 - 6.0	6.0 - 10.0	-	50.0	8.0 - 16.0	-	-	M3 - M8	60	-	83	
		2/4	2.0 - 5.0	6.0	6.0 - 16.0	50.0	0.5 - 6.0	-	0.5 - 6.0	-	-	-	86	
	+	3	4.0 - 5.0	6.0	6.0 - 10.0	50.0	1.0 - 3.0	-	1.0 - 3.0	-	-	-	87	
		2	0.8 - 2.4	3.0	-	40.0	0.3	-	0.3	-	-	-	88	
	+	1	0.05 - 6.0	4.0 - 6.0	-	40.0 - 50.0	-	-	-	-	20 - 180	-	90	
	+	1	0.1	6.0	-	50.0	-	-	-	-	30 - 90	-	92	
		1	0.1 - 0.2	6.0	-	50.0	-	-	-	-	20 - 90	-	93	
	+	1	0.1 - 0.2	4.0	-	40.0	-	-	-	-	30 - 45	-	94	
		2 - 6	3.0 - 15.0	3.0 - 6.0	1.6 - 6.0	40.0 - 50.0	0.8 - 4.5	6.0 - 25.0	-	-	-	-	96	
	+	1	0.1	6.0	-	61.0	-	-	-	-	90 - 120	-	98	
		2	3.0 - 6.0	3.0 - 6.0	2.0 - 5.0	39.0 - 50.0	0.29 - 6.0	6.0	-	-	5 - 60	-	100	

Cooling lubricants	110
General information	
Tool technology	114
Coatings	115
Guide values for speed and feed	116
CCT	117
Customised tools	117

DATRON

Single flute end mills

Milling tools with only one flute have a significant advantage when machining light alloys and plastics where high machining production and surface quality are important. Even so, users are often reluctant to use them. DATRON and the PTW (Institute for production management, technology and machine tools) have been able to eliminate all reservations in a joint scientific investigation. The advantages

of single flute end mills, particularly those with the patented DATRON counterweight grinding, are clear.

Superior single flute end mills

Customers have also frequently confirmed to us the superiority of the single flute end mill over the double flute end mill when faced with increased demands for machining quality and high chip volumes at the same time. In the PTW test aluminium test specimens were machined with single and double flute end mills using solid carbide flutes with ball nose and the resulting surface quality was tested.

Significantly improved roughness

The results clearly demonstrated that the single flute end mills generated consistently recurring feed marks on the work piece, which are characteristics of stable machining. In contrast,

the uneven tool tracks left the double flute end mills indicated a reduced quality of the surface finish. This was confirmed by the roughness values of the surfaces. After machining with the double flute end mill the Ra values were 60% and the Rz values 50% higher than the values achieved with the single flute end mill.

Optimal chip removal increases speed and quality

The explanation is relatively simple: to combine the objectives of chip volume as high as possible during roughing and high surface finish quality during finishing, chip accumulation and chip removal through the chip channel of the tool must be made as efficient as possible for the material and the process. Subject to this requirement, the geometry of the single flute end mill offers significant advantages over double or more flute mills with soft materials.

Counterweight grinding enables high speeds

The patented DATRON counterweight grinding can be described as the 'dot on the i'. The vibration velocity at the machine resonance peak can be more than halved in comparison with unbalanced single flute end mills. At higher velocities the single flute end mill is around 50% better (according to testing). This means that the stable cutting speed range is significantly higher.









Test it for yourself: one flute – many benefits!



DATRON

List of abbreviations

Legend

	Machinable materials		Flute with edge radius		Shank shape
	Flute number		Sharp-edged flute		Tip angle
	Carbide		Machining direction		Ball nose

D1	Flute diameter
D2	Shank diameter
D3	Shank toric diameter
L1	Total length
L2	Flute length
L3	Usable length
α	Angle
R	Radius
BS	Coating

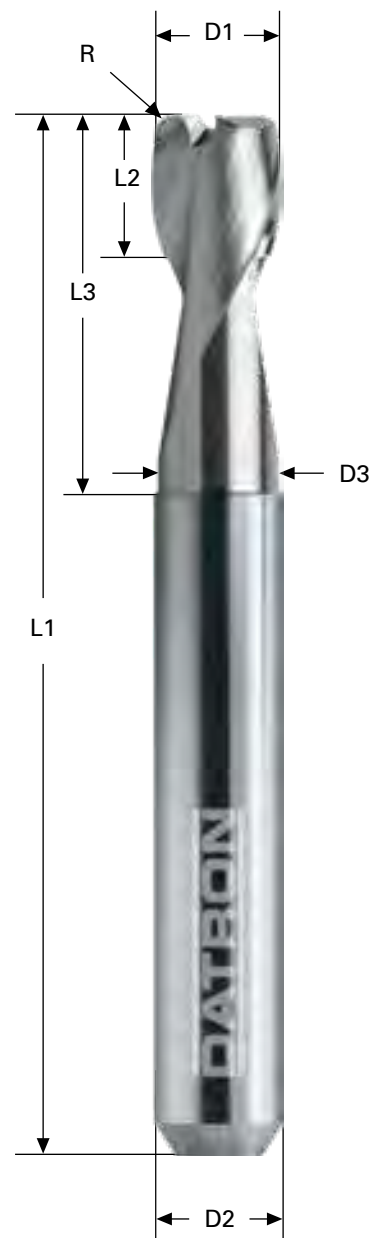

Shank mill

Single flute end mill 4-IN-1	12	Triple flute end mill, roughing cutter for copper	32
Single flute end mill balanced	14	Triple flute end mill, finishing cutter for copper	33
Single flute end mill	16	Triple flute end mill with toric cut	34
Single flute end mill with toric cut	18	Single flute end mill with polished flute for acrylic glass	35
Single flute end mill with coating (ALCRONA)	19	Triple flute end mill with coating (X.CEED)	36
Single flute end mill with polished flute for acrylic glass	20	Four flute end mill with coating (ALCRONA)	37
Single flute end mill left spiral, right cutting	21	Micro-toothed end mill	38
CrossCutter	22	Micro-toothed end mill with coating (X.CEED/diamond)	39
Double flute end mill	24	Diamond milling tool for CRP/GRP	40
Double flute end mill with toric cut	26		
Double flute end mill, contour cutter	27		
Double flute end mill HSC+	28		
Double flute end mill HSC Fire	29		
Double flute end mill with internal cooling	30		
Double flute end mill for machining steel	31		



DATRON

Single flute end mill 4-IN-1, balanced, faced, double polished

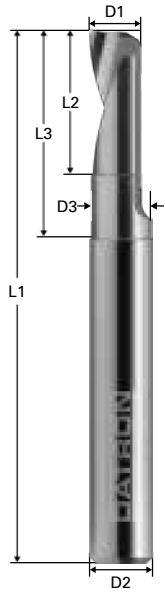

Aluminium Wood



Plastic



Copper Brass



Bronze



6 mm shank

Item no.	D1 (mm)	D2 (mm)	D3 (mm)	L1 (mm)	L2 (mm)	L3 (mm)
0068803A	3.0	6.0		40.0	5.0	
0068803K	3.0	6.0		45.0	9.0	
0068803E	3.0	6.0	2.8	50.0	9.0	13.0
0068803L	3.0	6.0	2.8	50.0	9.0	16.0
0068803X	3.0	6.0		50.0	13.0	
0068804A	4.0	6.0		40.0	5.0	
0068804K	4.0	6.0		45.0	9.0	
0068804E	4.0	6.0	3.7	50.0	9.0	16.0
0068804L	4.0	6.0	3.7	55.0	9.0	21.0
0068804X	4.0	6.0		55.0	16.0	
0068805A	5.0	6.0		45.0	7.0	
0068805K	5.0	6.0		50.0	11.0	
0068805E	5.0	6.0	4.6	60.0	11.0	21.0
0068805L	5.0	6.0	4.6	60.0	11.0	26.0
0068805X	5.0	6.0		55.0	16.0	
0068806A	6.0	6.0		45.0	7.0	
0068806K	6.0	6.0		50.0	13.0	
0068806E	6.0	6.0	5.5	60.0	13.0	26.0
0068806L	6.0	6.0	5.5	65.0	13.0	31.0
0068806X	6.0	6.0		55.0	21.0	

8 mm shank

Item no.	D1 (mm)	D2 (mm)	D3 (mm)	L1 (mm)	L2 (mm)	L3 (mm)
0068808A	8.0	8.0		45.0	9.0	
0068808K	8.0	8.0		55.0	17.0	
0068808E	8.0	8.0	7.4	65.0	17.0	31.0
0068808L	8.0	8.0	7.4	75.0	17.0	41.0
0068808X	8.0	8.0		65.0	26.0	

10 mm shank

Item no.	D1 (mm)	D2 (mm)	D3 (mm)	L1 (mm)	L2 (mm)	L3 (mm)
0068810A	10.0	10.0		50.0	11.0	
0068810K	10.0	10.0		60.0	21.0	
0068810E	10.0	10.0	9.2	75.0	21.0	41.0
0068810L	10.0	10.0	9.2	85.0	21.0	51.0
0068810X	10.0	10.0		70.0	32.0	

12 mm shank

Item no.	D1 (mm)	D2 (mm)	D3 (mm)	L1 (mm)	L2 (mm)	L3 (mm)
0068812A	12.0	12.0		55.0	14.0	
0068812K	12.0	12.0		65.0	26.0	
0068812E	12.0	12.0	11.0	85.0	26.0	51.0
0068812L	12.0	12.0	11.0	95.0	26.0	61.0
0068812X	12.0	12.0		75.0	36.0	

DATRON

Single flute end mill balanced

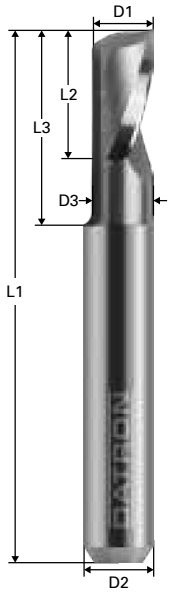

Aluminium

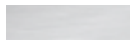

Plastic



Wood



Copper



Bronze



Brass



6 mm shank

Item no.	D1 (mm)	D2 (mm)	D3 (mm)	L1 (mm)	L2 (mm)	L3 (mm)
0068085E	5.0	6.0	4.8	50.0	8.75	13.5
0068086C	6.0	6.0		50.0	8.0	
0068086E	6.0	6.0	5.5	50.0	10.5	16.5
0068086H	6.0	6.0		50.0	14.0	
0068086L	6.0	6.0	5.5	50.0	16.0	23.5
0068086P	6.0	6.0		60.0	20.0	
0068086X	6.0	6.0	5.5	55.0	21.0	27.0
0068086Y	6.0	6.0		58.0	25.0	
0068086Z	6.0	6.0		65.0	30.0	

8 mm shank

Item no.	D1 (mm)	D2 (mm)	D3 (mm)	L1 (mm)	L2 (mm)	L3 (mm)
0068085S	5.0	8.0	4.8	50.0	8.75	13.5
0068086S	6.0	8.0	5.5	50.0	10.5	16.5
0068087E	7.0	8.0		60.0	14.0	
0068088K	8.0	8.0	7.4	50.0	8.0	12.5
0068088C	8.0	8.0		60.0	14.0	
0068088E	8.0	8.0	7.4	60.0	14.0	26.0
0068080D	8.0	8.0	7.4	70.0	14.0	43.0
0068088H	8.0	8.0		60.0	20.0	
0068088S	8.0	8.0	7.4	60.0	21.0	31.0
0068088V	8.0	8.0		60.0	25.0	
0068088L	8.0	8.0	7.4	60.0	26.0	34.0
0068088X	8.0	8.0	7.4	70.0	31.0	42.0
0068088Z	8.0	8.0		80.0	32.0	

10 mm shank

Item no.	D1 (mm)	D2 (mm)	D3 (mm)	L1 (mm)	L2 (mm)	L3 (mm)
0068090K	10.0	10.0	9.2	50.0	10.0	15.6
0068090E	10.0	10.0	9.2	60.0	17.5	27.5
0068090S	10.0	10.0	9.2	80.0	17.5	52.0
0068090P	10.0	10.0		60.0	20.0	
0068090L	10.0	10.0	9.2	60.0	26.0	34.0
0068090M	10.0	10.0	9.2	85.0	26.0	34.0
0068090X	10.0	10.0	9.2	70.0	32.5	42.5
0068090Y	10.0	10.0		100.0	40.0	

12 mm shank

Item no.	D1 (mm)	D2 (mm)	D3 (mm)	L1 (mm)	L2 (mm)	L3 (mm)
0068092K	12.0	12.0	11.0	60.0	12.0	19.0
0068092E	12.0	12.0	11.0	70.0	21.0	33.0
0068092L	12.0	12.0	11.0	70.0	31.5	42.0

DATRON

Single flute end mill

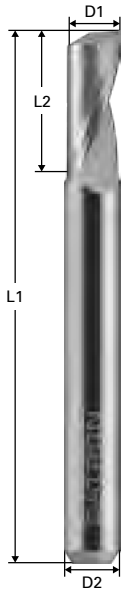

Aluminium Wood



Plastic



Copper Brass



Bronze



3 mm shank

Item no.	D1 (mm)	D2 (mm)	L1 (mm)	L2 (mm)
0068003E	0.3	3.0	38.0	1.0
0068004E	0.4	3.0	38.0	1.0
0068005E	0.5	3.0	38.0	1.5
0068006E	0.6	3.0	38.0	2.5
0068008E	0.8	3.0	38.0	3.0
0068010E	1.0	3.0	38.0	4.0
0068015E	1.5	3.0	38.0	5.0
0068016E	1.6	3.0	38.0	5.0
0068020G	2.0	3.0	40.0	6.0
0068020E	2.0	3.0	40.0	8.0
0068020L	2.0	3.0	40.0	10.0
0068020W	2.0	3.0	65.0	15.0
0068024A	2.4	3.0	40.0	5.5
0068024E	2.4	3.0	40.0	8.0
0068024L	2.4	3.0	40.0	10.0
0068030E	3.0	3.0	40.0	10.0
0068030Y	3.0	3.0	65.0	10.0
0068030Z	3.0	3.0	40.0	10.5
0068030W	3.0	3.0	65.0	15.0

1/8" shank

Item no.	D1 (mm)	D2 (mm)	L1 (mm)	L2 (mm)
0068606E	0.6	3175	38.0	3.0
0068608E	0.8	3175	38.0	3.0
0068610E	1.0	3175	38.0	3.0
0068612E	1.2	3175	38.0	4.0
0068615E	1.5	3175	38.0	4.0
0068620G	2.0	3175	40.0	5.0
0068620E	2.0	3175	38.0	8.0
0068620F	2.0	3175	40.0	11.5
0068624E	2.4	3175	38.0	8.0
0068630E	3.0	3175	38.0	9.0
0068630F	3.0	3175	40.0	11.5

4 mm shank

Item no.	D1 (mm)	D2 (mm)	L1 (mm)	L2 (mm)
0068415Y	1.5	4.0	40.0	5.0
0068432Y	2.0	4.0	40.0	8.0
0068430Y	3.0	4.0	40.0	10.0
0068434Y	4.0	4.0	40.0	10.0

6 mm shank

Item no.	D1 (mm)	D2 (mm)	L1 (mm)	L2 (mm)
0068410E	1.0	6.0	50.0	4.0
0068415A	1.5	6.0	50.0	3.0
0068415E	1.5	6.0	50.0	7.0
0078415E	1.5	6.0	58.0	7.0
0068432A	2.0	6.0	50.0	5.0
0068432E	2.0	6.0	50.0	7.0
0078420E	2.0	6.0	58.0	7.0
0068432L	2.0	6.0	50.0	11.0
0078424E	2.4	6.0	50.0	8.0
0068425A	2.5	6.0	50.0	5.0
0078425E	2.5	6.0	58.0	8.0
0068430A	3.0	6.0	50.0	5.0
0068430E	3.0	6.0	50.0	8.0
0078430E	3.0	6.0	58.0	8.0
0068430S	3.0	6.0	50.0	10.0
0078430S	3.0	6.0	58.0	10.0
0068430L	3.0	6.0	50.0	12.0
0078435E	3.5	6.0	58.0	10.0
0068434A	4.0	6.0	50.0	5.0
0068434B	4.0	6.0	50.0	7.0
0068434E	4.0	6.0	50.0	10.0
0078440E	4.0	6.0	58.0	10.0
0068434L	4.0	6.0	50.0	12.0
0068434Z	4.0	6.0	45.0	14.0
0068434S	4.0	6.0	60.0	14.0
0078440L	4.0	6.0	58.0	18.0
0068434F	4.0	6.0	58.0	20.0
0068435B	5.0	6.0	50.0	8.0
0068435E	5.0	6.0	50.0	12.0
0068435L	5.0	6.0	58.0	22.0
0068460C	6.0	6.0	50.0	8.0
0068460E	6.0	6.0	50.0	14.0
0068460L	6.0	6.0	60.0	20.0
0068460A	6.0	6.0	58.0	25.0
0068460B	6.0	6.0	65.0	30.0

8 mm shank

Item no.	D1 (mm)	D2 (mm)	L1 (mm)	L2 (mm)
0068079E	7.0	8.0	60.0	14.0
0068080E	8.0	8.0	60.0	14.0
0068080L	8.0	8.0	60.0	20.0
0068080A	8.0	8.0	60.0	25.0
0068080B	8.0	8.0	80.0	32.0

10 mm shank

Item no.	D1 (mm)	D2 (mm)	L1 (mm)	L2 (mm)
0068470E	10.0	10.0	60.0	20.0
0068470L	10.0	10.0	100.0	40.0

DATRON

Single flute end mill with toric cut

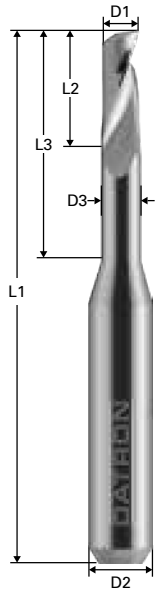

Aluminium

Wood

Copper

Brass



Plastic



Bronze



6 mm shank

Item no.	D1 (mm)	D2 (mm)	D3 (mm)	L1 (mm)	L2 (mm)	L3 (mm)
00684910	1.0	6.0	0.9	50.0	4.0	7.0
00684915	1.5	6.0	1.4	50.0	7.0	11.0
0068492K	2.0	6.0	1.8	50.0	4.0	12.0
0068492E	2.0	6.0	1.8	50.0	7.0	14.0
0068493K	3.0	6.0	2.7	50.0	4.0	14.0
0068493E	3.0	6.0	2.7	50.0	8.0	14.0
0068493D	3.0	6.0	2.7	50.0	4.0	17.0
0068493S	3.0	6.0	2.7	50.0	8.0	17.0
0068493F	3.0	6.0	2.7	50.0	4.0	21.0
0068493L	3.0	6.0	2.7	50.0	8.0	21.0
0068494K	4.0	6.0	3.6	50.0	5.0	18.0
0068494E	4.0	6.0	3.6	50.0	10.0	18.0
0068494D	4.0	6.0	3.6	50.0	5.0	21.0
0068494S	4.0	6.0	3.6	50.0	10.0	21.0
0068495K	5.0	6.0	4.4	60.0	5.0	22.0
0068495E	5.0	6.0	4.4	50.0	12.0	22.0
0068496K	6.0	6.0	5.3	60.0	5.0	24.0
0068496E	6.0	6.0	5.3	50.0	14.0	24.0
0068496F	6.0	6.0	5.3	60.0	5.0	30.0
0068496L	6.0	6.0	5.3	60.0	14.0	30.0

Single flute end mill with coating (ALCRONA)

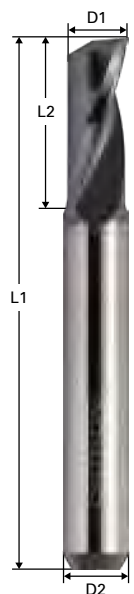

Bronze



Aluminium



Wood



Brass



GRP/CRP



6 mm shank

Item no.	D1 (mm)	D2 (mm)	L1 (mm)	L2 (mm)
0068932A	2.0	6.0	50.0	5.0
0068932E	2.0	6.0	50.0	7.0
0068930E	3.0	6.0	50.0	8.0
0068930S	3.0	6.0	50.0	10.0
0068930L	3.0	6.0	50.0	12.0
0068934E	4.0	6.0	50.0	10.0
0068934S	4.0	6.0	50.0	14.0
0068934L	4.0	6.0	58.0	20.0
0068935E	5.0	6.0	50.0	12.0
0068935L	5.0	6.0	58.0	22.0
0068960E	6.0	6.0	50.0	14.0
0068960L	6.0	6.0	58.0	20.0

DATRON

Single flute end mill with polished flute for acrylic glass

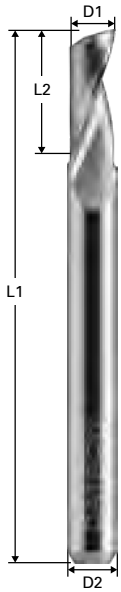

Acrylic glass



Plastic



Item no.	D1 (mm)	D2 (mm)	L1 (mm)	L2 (mm)
0078310E	1.0	6.0	50.0	4.0
0078320E	2.0	6.0	50.0	7.0
0078320L	2.0	6.0	50.0	11.0
0078330E	3.0	6.0	50.0	8.0
0078330L	3.0	6.0	50.0	12.0
0078334E	4.0	6.0	50.0	10.0
0078334L	4.0	6.0	60.0	22.0
0078335E	5.0	6.0	50.0	12.0
0078335L	5.0	6.0	60.0	22.0
0078360E	6.0	6.0	50.0	14.0
0078360L	6.0	6.0	60.0	22.0
0078338E	8.0	8.0	60.0	22.0
0078338L	8.0	8.0	70.0	32.0
0078339E	10.0	10.0	75.0	32.0

Single flute end mill left spiral, right cutting

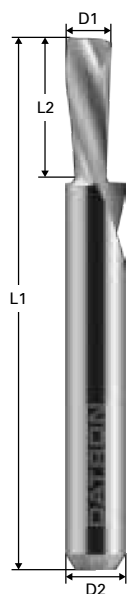

Aluminium

Wood

Bronze



Plastic

Brass



6 mm shank

Item no.	D1 (mm)	D2 (mm)	L1 (mm)	L2 (mm)
0068471E	1.5	6.0	50.0	7.0
0068472E	2.0	6.0	50.0	7.0
0068473E	3.0	6.0	50.0	8.0
0068474E	4.0	6.0	50.0	10.0
0068475E	5.0	6.0	50.0	12.0
0068476E	6.0	6.0	50.0	14.0
0068476L	6.0	6.0	60.0	20.0

DATRON

CrossCutter

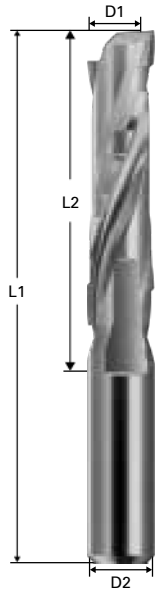

Aluminium



Plastic



Wood



Copper



Bronze



Brass



6 mm shank

Item no.	D1 (mm)	D2 (mm)	L1 (mm)	L2 (mm)
00688006E	6	6	58	21
00688006L	6	6	68	26

8 mm shank

Item no.	D1 (mm)	D2 (mm)	L1 (mm)	L2 (mm)
00688008E	8	8	68	26
00688008L	8	8	70	31

10 mm shank

Item no.	D1 (mm)	D2 (mm)	L1 (mm)	L2 (mm)
00688010E	10	10	72	31
00688010L	10	10	80	41

12 mm shank

Item no.	D1 (mm)	D2 (mm)	L1 (mm)	L2 (mm)
00688012E	12	12	80	41
00688012L	12	12	90	51

DATRON

Double flute end mill

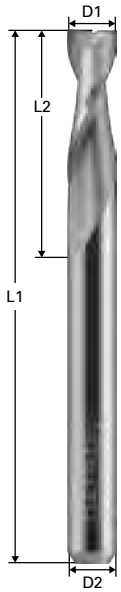

Aluminium

Brass

Bronze



Copper

Plastic

Wood



3 mm shank

Item no.	D1 (mm)	D2 (mm)	L1 (mm)	L2 (mm)
00680010	0.1	3.0	38.0	0.2
00680020	0.2	3.0	39.0	0.4
00680025	0.25	3.0	39.0	0.4
0068003	0.3	3.0	39.0	0.9
0068004K	0.4	3.0	38.0	0.6
0068004	0.4	3.0	38.0	2.5
0068005K	0.5	3.0	38.0	1.0
0068005	0.5	3.0	38.0	2.5
0068006K	0.6	3.0	38.0	1.0
0068006	0.6	3.0	38.0	3.0
0068008	0.8	3.0	38.0	4.0
0068009	0.9	3.0	38.0	5.0
0068010S	1.0	3.0	38.0	2.3
0068010K	1.0	3.0	38.0	3.0
0068010	1.0	3.0	38.0	5.0
0068010L	1.0	3.0	40.0	8.0
0068012S	1.2	3.0	38.0	2.3
0068012K	1.2	3.0	38.0	3.0
0068012	1.2	3.0	38.0	5.0
0068015	1.5	3.0	38.0	5.0
0068015S	1.5	3.0	38.0	10.0
0068016	1.6	3.0	38.0	6.0
0068020K	2.0	3.0	38.0	4.0
0068020	2.0	3.0	38.0	9.0
0068024K	2.4	3.0	38.0	5.0
0068024	2.4	3.0	40.0	8.0
0068030K	3.0	3.0	40.0	6.0
0068030A	3.0	3.0	40.0	10.0
0068030L	3.0	3.0	40.0	12.0
0068030X	3.0	3.0	60.0	25.0

1/8" shank

Item no.	D1 (mm)	D2 (mm)	L1 (mm)	L2 (mm)
0068604	0.4	3175	38.0	2.5
0068605	0.5	3175	38.0	3.0
0068606	0.6	3175	38.0	3.0
0068608	0.8	3175	38.0	5.0
0068609	0.9	3175	38.0	5.0
0068610K	1.0	3175	38.0	3.0
0068610	1.0	3175	38.0	4.0
0068612	1.2	3175	38.0	5.0
0068613	1.3	3175	38.0	5.0
0068615	1.5	3175	38.0	6.0
0068616	1.6	3175	38.0	6.0
0068617	1.7	3175	38.0	6.0
0068618	1.8	3175	38.0	6.0
0068620K	2.0	3175	38.0	4.0
0068620	2.0	3175	38.0	8.0
0068624K	2.4	3175	38.0	5.0
0068624	2.4	3175	38.0	8.0
0068625	2.5	3175	38.0	8.0
0068630K	3.0	3175	38.0	6.0
0068630	3.0	3175	38.0	10.0

6 mm shank

Item no.	D1 (mm)	D2 (mm)	L1 (mm)	L2 (mm)
0068430K	3.0	6.0	40.0	6.0
0068430	3.0	6.0	50.0	7.0
0068430G	3.0	6.0	50.0	11.0
0068434K	4.0	6.0	40.0	6.0
0068434	4.0	6.0	50.0	8.0
0068435K	5.0	6.0	40.0	6.0
0068435A	5.0	6.0	50.0	8.0
0068435	5.0	6.0	50.0	10.0
0068460Y	6.0	6.0	40.0	6.0
0068460K	6.0	6.0	50.0	10.0
0068460	6.0	6.0	50.0	18.0
0068460G	6.0	6.0	58.0	20.0
0068460X	6.0	6.0	75.0	30.0
0068460W	6.0	6.0	75.0	40.0
0068460Z	6.0	6.0	100.0	40.0

8 mm shank

Item no.	D1 (mm)	D2 (mm)	L1 (mm)	L2 (mm)
0068081	8.0	8.0	63.0	16.0
0068081L	8.0	8.0	60.0	32.0
0068082	8.0	8.0	100.0	40.0

10 mm shank

Item no.	D1 (mm)	D2 (mm)	L1 (mm)	L2 (mm)
0068100	10.0	10.0	40.0	10.0
0068100A	10.0	10.0	72.0	25.0
0068100L	10.0	10.0	72.0	32.0
0068083	10.0	10.0	100.0	40.0

12 mm shank

Item no.	D1 (mm)	D2 (mm)	L1 (mm)	L2 (mm)
0078812L	12.0	12.0	60.0	20.0
0078812B	12.0	12.0	60.0	30.0

DATRON

Double flute end mill with toric cut

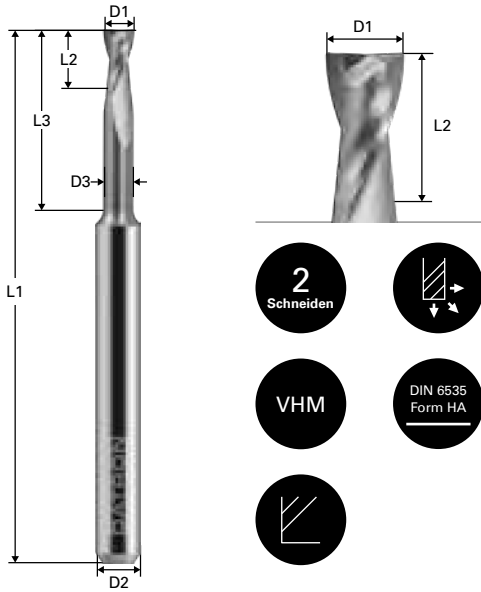

Aluminium

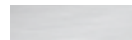

Copper



Brass



Plastic



Bronze



Wood



3 mm shank

Item no.	D1 (mm)	D2 (mm)	D3 (mm)	L1 (mm)	L2 (mm)	L3 (mm)
00781005	0.5	3.0	0.45	40.0	0.75	4.0
00781006	0.6	3.0	0.55	40.0	0.9	4.0
00781007	0.7	3.0	0.65	38.0	1.05	4.0
00781008	0.8	3.0	0.75	38.0	1.2	6.0
00781009	0.9	3.0	0.85	38.0	1.3	6.0
00781010	1.0	3.0	0.95	38.0	1.5	6.0
00781011	1.0	3.0	0.95	38.0	1.5	9.0
00781012	1.2	3.0	1.15	38.0	1.8	9.0
00781015	1.5	3.0	1.45	38.0	2.2	9.0
00781020	2.0	3.0	1.95	38.0	3.0	12.0
00781025	2.5	3.0	2.4	40.0	3.5	15.0

6 mm shank

Item no.	D1 (mm)	D2 (mm)	D3 (mm)	L1 (mm)	L2 (mm)	L3 (mm)
00781034	4.0	6.0	3.8	50.0	8.0	16.0
0078806	6.0	6.0	5.7	60.0	10.0	22.0
00781036	6.0	6.0	5.7	60.0	20.0	33.0

8 mm shank

Item no.	D1 (mm)	D2 (mm)	D3 (mm)	L1 (mm)	L2 (mm)	L3 (mm)
0078808	8.0	8.0	7.7	60.0	10.0	24.0

10 mm shank

Item no.	D1 (mm)	D2 (mm)	D3 (mm)	L1 (mm)	L2 (mm)	L3 (mm)
0078810	10.0	10.0	9.7	50.0	10.0	20.0
0078810L	10.0	10.0	9.8	70.0	17.0	35.0

12 mm shank

Item no.	D1 (mm)	D2 (mm)	D3 (mm)	L1 (mm)	L2 (mm)	L3 (mm)
0078812	12.0	12.0	11.7	50.0	10.0	20.0

Double flute end mill contour cutter

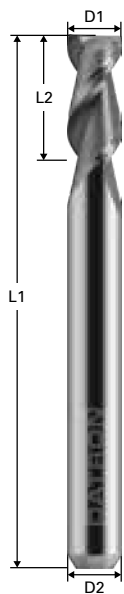

Aluminium

Plastic

Wood



Brass



Item no.	D1 (mm)	D2 (mm)	L1 (mm)	L2 (mm)
0068033	3.0	6.0	57.0	8.0
0068034	4.0	6.0	57.0	11.0
0068035	5.0	6.0	57.0	13.0
0068036	6.0	6.0	57.0	13.0
0068040	8.0	8.0	60.0	20.0
0068041	8.0	8.0	60.0	25.0
0068042	10.0	10.0	70.0	25.0
0068043	12.0	12.0	70.0	25.0

DATRON

Double flute end mill HSC+

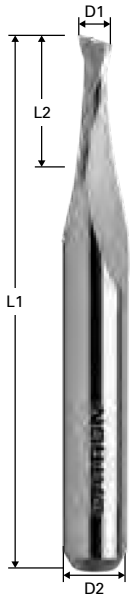

Plastic



Aluminium



Brass



Copper



Wood



3 mm shank

Item no.	D1 (mm)	D2 (mm)	L1 (mm)	L2 (mm)
0068815A	1.5	3.0	40.0	6.0
0068820A	2.0	3.0	40.0	6.0
0068830A	3.0	3.0	40.0	10.0

1/8" shank

Item no.	D1 (mm)	D2 (mm)	L1 (mm)	L2 (mm)
0068815	1.5	3175	40.0	6.0
0068820	2.0	3175	40.0	6.0
0068824	2.4	3175	40.0	6.0
0068830K	3.0	3175	40.0	6.0
0068830	3.0	3175	40.0	10.0

6 mm shank

Item no.	D1 (mm)	D2 (mm)	L1 (mm)	L2 (mm)
0068866	1.9	6.0	50.0	6.0
0068862K	2.0	6.0	50.0	4.0
0068862	2.0	6.0	50.0	6.0
0068867	2.4	6.0	50.0	5.0
0068863K	3.0	6.0	50.0	6.0
0068863	3.0	6.0	50.0	10.0
0068864	4.0	6.0	50.0	8.0
0068865	5.0	6.0	50.0	10.0
0068860K	6.0	6.0	50.0	7.0
0068860	6.0	6.0	58.0	12.0

Double flute end mill HSC Fire

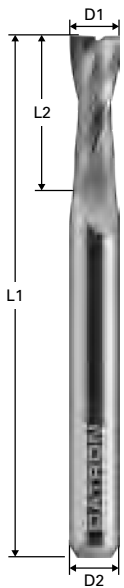

- 2 Schneiden
- VHM
- DIN 6535 Form HA
-

- Aluminium
- Plastic
- Brass
- Wood

6 mm shank

Item no.	D1 (mm)	D2 (mm)	L1 (mm)	L2 (mm)
0068876S	6.0	6.0	50.0	12.0
0068876K	6.0	6.0	50.0	17.0
0068876	6.0	6.0	60.0	22.0
0068876L	6.0	6.0	70.0	32.0

8 mm shank

Item no.	D1 (mm)	D2 (mm)	L1 (mm)	L2 (mm)
0068878S	8.0	8.0	50.0	12.0
0068878K	8.0	8.0	50.0	17.0
0068878	8.0	8.0	60.0	22.0
0068878L	8.0	8.0	70.0	32.0

10 mm shank

Item no.	D1 (mm)	D2 (mm)	L1 (mm)	L2 (mm)
0068870S	10.0	10.0	50.0	12.0
0068870K	10.0	10.0	50.0	17.0
0068870	10.0	10.0	60.0	22.0
0068870L	10.0	10.0	70.0	32.0

DATRON

Double flute end mill with internal cooling

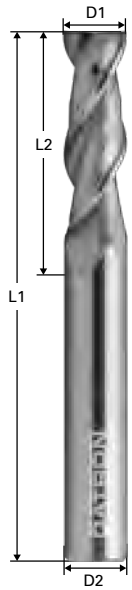

6 mm shank

Item no.	D1 (mm)	D2 (mm)	D3 (mm)	L1 (mm)	L2 (mm)	L3 (mm)
0068906K	6.0	6.0		60.0	14.0	
0068906	6.0	6.0		60.0	22.0	
0068906L	6.0	6.0	5.6	60.0	22.0	32.0

8 mm shank

Item no.	D1 (mm)	D2 (mm)	D3 (mm)	L1 (mm)	L2 (mm)	L3 (mm)
0068908K	8.0	8.0		60.0	16.0	
0068908	8.0	8.0		60.0	22.0	
0068908L	8.0	8.0	7.4	60.0	22.0	32.0

10 mm shank

Item no.	D1 (mm)	D2 (mm)	D3 (mm)	L1 (mm)	L2 (mm)	L3 (mm)
0068910K	10.0	10.0		70.0	26.0	
0068910	10.0	10.0		70.0	32.0	
0068910L	10.0	10.0	9.2	70.0	32.0	38.0

12 mm shank

Item no.	D1 (mm)	D2 (mm)	D3 (mm)	L1 (mm)	L2 (mm)	L3 (mm)
0068912K	12.0	12.0		80.0	26.0	
0068912	12.0	12.0		80.0	32.0	
0068912L	12.0	12.0	11.2	80.0	32.0	48.0

Double flute end mill for machining steel (X.CEED)

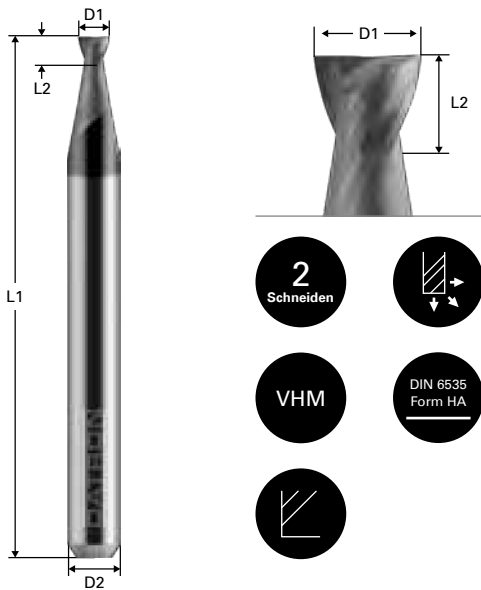

Steel



3 mm shank

Item no.	D1 (mm)	D2 (mm)	L1 (mm)	L2 (mm)
0078009S	0.9	3.0	38.0	1.1
0078009K	0.9	3.0	38.0	1.8
0078010S	1.0	3.0	38.0	1.2
0078010K	1.0	3.0	38.0	2.0
0078011S	1.1	3.0	38.0	1.2
0078011K	1.1	3.0	38.0	2.2
0078012S	1.2	3.0	38.0	1.2
0078012K	1.2	3.0	38.0	2.4
0078013S	1.3	3.0	38.0	1.2
0078013K	1.3	3.0	38.0	2.6
0078014S	1.4	3.0	38.0	1.4
0078014K	1.4	3.0	38.0	2.8
0078015S	1.5	3.0	38.0	1.4
0078015K	1.5	3.0	38.0	3.0
0078016S	1.6	3.0	38.0	1.4
0078016K	1.6	3.0	38.0	3.2
0078017S	1.7	3.0	38.0	1.4
0078017K	1.7	3.0	38.0	3.4
0078018S	1.8	3.0	38.0	1.5
0078018K	1.8	3.0	38.0	3.6
0078019S	1.9	3.0	38.0	1.5
0078019K	1.9	3.0	38.0	4.0
0078020S	2.0	3.0	38.0	1.8
0078020K	2.0	3.0	38.0	6.0
0078021K	2.1	3.0	38.0	5.0
0078022K	2.2	3.0	38.0	5.0
0078023K	2.3	3.0	38.0	5.0
0078024K	2.4	3.0	38.0	5.0
0078025S	2.5	3.0	38.0	2.0
0078025K	2.5	3.0	38.0	7.0
0078030K	3.0	3.0	38.0	7.0

DATRON

Triple flute end mill roughing cutter for copper

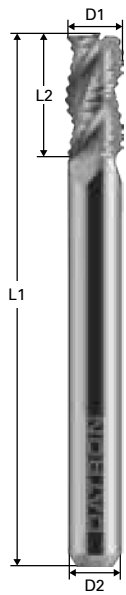

Copper



Item no.	D1 (mm)	D2 (mm)	L1 (mm)	L2 (mm)
00685903	3.0	6.0	50.0	6.0
00685906	6.0	6.0	50.0	12.0
00685908	8.0	8.0	50.0	16.0
00685910	10.0	10.0	60.0	22.0

Triple flute end mill finishing cutter for copper

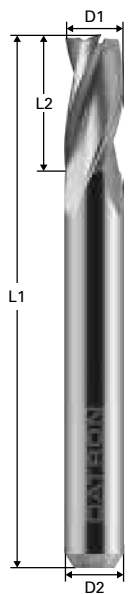

Copper



Item no.	D1 (mm)	D2 (mm)	L1 (mm)	L2 (mm)
00685610	1.0	6.0	50.0	2.2
00685615	1.5	6.0	50.0	3.2
00685620	2.0	6.0	50.0	4.2
00685630	3.0	6.0	50.0	6.0
00685640	4.0	6.0	50.0	8.0
00685660	6.0	6.0	50.0	11.0
00685680	8.0	8.0	50.0	16.0

DATRON

Triple flute end mill with toric cut

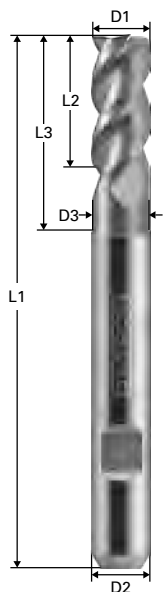

Brass

Aluminium

Copper

Wood

Item no.	D1 (mm)	D2 (mm)	D3 (mm)	L1 (mm)	L2 (mm)	L3 (mm)
0068033A	3.0	6.0	2.8	58.0	8.0	12.0
0068034A	4.0	6.0	3.8	58.0	11.0	16.0
0068035A	5.0	6.0	4.8	58.0	13.0	19.0
0068036A	6.0	6.0	5.7	58.0	13.0	19.0
0068040A	8.0	8.0	7.8	63.0	19.0	27.0
0068042A	10.0	10.0	9.8	72.0	22.0	32.0
0068043A	12.0	12.0	11.8	83.0	26.0	38.0

Triple flute end mill with toric cut for foam

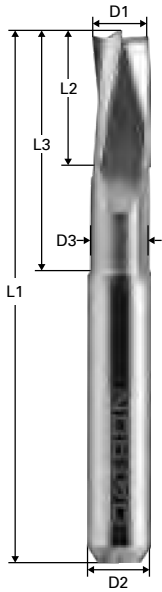

Foams



6 mm shank

Item no.	D1 (mm)	D2 (mm)	D3 (mm)	L1 (mm)	L2 (mm)	L3 (mm)
00680530	3.0	6.0	2.7	75.0	12.0	41.0
0068053K	3.0	6.0	2.7	50.0	6.0	22.0
00680540	4.0	6.0	3.6	75.0	15.0	41.0
0068054K	4.0	6.0	3.6	50.0	8.0	22.0
00680550	5.0	6.0	4.5	75.0	20.0	41.0
0068055K	5.0	6.0	4.5	50.0	12.0	22.0
00680560	6.0	6.0	5.5	75.0	27.0	42.0
0068056A	6.0	6.0	5.5	100.0	27.0	71.0
0068056K	6.0	6.0	5.5	50.0	12.0	22.0

8 mm shank

Item no.	D1 (mm)	D2 (mm)	D3 (mm)	L1 (mm)	L2 (mm)	L3 (mm)
00680580	8.0	8.0	7.5	75.0	28.0	42.0
0068058A	8.0	8.0	7.5	100.0	42.0	71.0
0068058K	8.0	8.0	7.5	50.0	16.0	25.0

10 mm shank

Item no.	D1 (mm)	D2 (mm)	D3 (mm)	L1 (mm)	L2 (mm)	L3 (mm)
00680510	10.0	10.0	9.5	115.0	52.0	82.0
0068051K	10.0	10.0	9.5	60.0	20.0	30.0

DATRON

Triple flute end mill with coating (X.CEED)

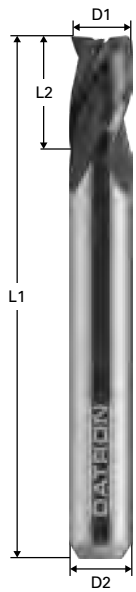

Steel



Item no.	D1 (mm)	D2 (mm)	L1 (mm)	L2 (mm)
0068551	1.75	3.0	40.0	3.0
0068552	2.0	6.0	50.0	6.0
0068553	3.0	6.0	50.0	6.0
0068554	4.0	6.0	50.0	8.0
0068555	5.0	6.0	50.0	10.0
0068556	6.0	6.0	50.0	10.0

Four flute end mill with coating (ALCRONA)

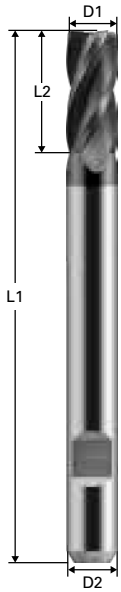

Steel



6 mm shank

Item no.	D1 (mm)	D2 (mm)	L1 (mm)	L2 (mm)
0078402	2.0	6.0	50.0	7.0
00784025	2.5	6.0	50.0	8.0
0078403	3.0	6.0	57.0	8.0
0078403A	3.0	6.0	57.0	19.0
00784035	3.5	6.0	57.0	10.0
0078404	4.0	6.0	57.0	11.0
0078404A	4.0	6.0	57.0	19.0
0078404B	4.0	6.0	75.0	25.0
00784045	4.5	6.0	57.0	11.0
0078405	5.0	6.0	57.0	13.0
0078405A	5.0	6.0	75.0	30.0
00784055	5.5	6.0	57.0	13.0
0078406	6.0	6.0	57.0	13.0
0078406A	6.0	6.0	75.0	30.0
0078406B	6.0	6.0	100.0	40.0

8 mm shank

Item no.	D1 (mm)	D2 (mm)	L1 (mm)	L2 (mm)
00784065	6.5	8.0	63.0	16.0
0078407	7.0	8.0	63.0	16.0
0078408	8.0	8.0	63.0	19.0
0078408A	8.0	8.0	75.0	30.0

10 mm shank

Item no.	D1 (mm)	D2 (mm)	L1 (mm)	L2 (mm)
0078409	9.0	10.0	72.0	19.0
0078410	10.0	10.0	72.0	22.0
0078410A	10.0	10.0	75.0	30.0
0078410B	10.0	10.0	100.0	40.0

12 mm shank

Item no.	D1 (mm)	D2 (mm)	L1 (mm)	L2 (mm)
0078412	12.0	12.0	83.0	26.0
0078412A	12.0	12.0	100.0	45.0

DATRON

Micro-toothed end mill

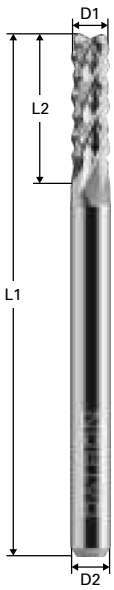

GRP/CRP



3 mm shank

Item no.	D1 (mm)	D2 (mm)	L1 (mm)	L2 (mm)
0068106	0.6	3.0	38.0	3.0
0068107	0.7	3.0	38.0	3.5
0068108	0.8	3.0	38.0	5.0
0068110	1.0	3.0	38.0	5.0
0068111	1.1	3.0	38.0	5.0
0068112	1.2	3.0	38.0	5.0
0068115	1.5	3.0	38.0	8.0
0068120	2.0	3.0	38.0	8.0
0068124	2.4	3.0	38.0	8.0
0068130	3.0	3.0	38.0	12.0

1/8" shank

Item no.	D1 (mm)	D2 (mm)	L1 (mm)	L2 (mm)
00686506	0.6	3175	38.0	3.0
00686508	0.8	3175	38.0	5.0
00686510	1.0	3175	38.0	5.0
00686511	1.1	3175	38.0	7.0
00686512	1.2	3175	38.0	7.0
00686513	1.3	3175	38.0	7.0
00686514	1.4	3175	38.0	7.0
00686515	1.5	3175	38.0	7.0
00686516	1.6	3175	38.0	8.5
00686517	1.7	3175	38.0	8.5
00686518	1.8	3175	38.0	8.5
00686519	1.9	3175	38.0	8.5
00686520	2.0	3175	38.0	8.0
00686521	2.1	3175	38.0	9.0
00686522	2.2	3175	38.0	9.0
00686523	2.3	3175	38.0	9.0
00686524	2.4	3175	38.0	9.0
00686530	3.0	3175	38.0	10.0

Micro-toothed end mill with coating (X.CEED/diamond)

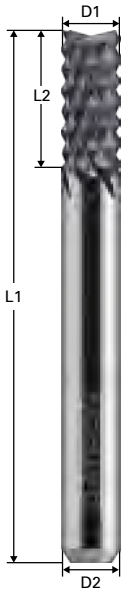

- 8**
Schneiden
- DIN 6535
Form HA
- VHM
-
-



GRP/CRP



3 mm shank

Item no.	D1 (mm)	D2 (mm)	L1 (mm)	L2 (mm)	BS
006T106	0.6	3.0	40.0	3.0	X.CEED
006T107	0.7	3.0	40.0	3.5	X.CEED
006T110	1.0	3.0	40.0	5.0	X.CEED
006T115	1.5	3.0	40.0	8.0	X.CEED
006T120	2.0	3.0	40.0	8.0	X.CEED
006T124	2.4	3.0	40.0	8.0	X.CEED
006T130	3.0	3.0	40.0	12.0	X.CEED

1/8" shank

Item no.	D1 (mm)	D2 (mm)	L1 (mm)	L2 (mm)	BS
0073126B	2.0	3175	38.0	9.0	Diamond
0073126C	2.4	3175	38.0	9.0	Diamond
0073126D	3.0	3175	38.0	9.0	Diamond

6 mm shank

Item no.	D1 (mm)	D2 (mm)	L1 (mm)	L2 (mm)	BS
0068164	4.0	6.0	50.0	16.0	X.CEED
0068165	5.0	6.0	50.0	22.0	X.CEED
0068166S	6.0	6.0	50.0	12.0	X.CEED

DATRON

Diamond milling tool for CRP/GRP

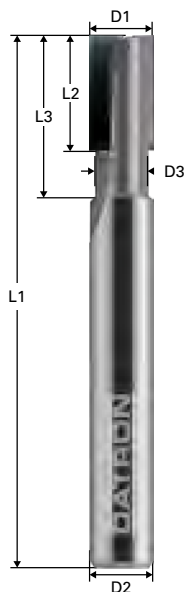

1-2
Schneiden



CVD

DIN 6535
Form HA



CRP/GRP



Item no.	D1 (mm)	D2 (mm)	D3 (mm)	L1 (mm)	L2 (mm)	L3 (mm)	Number of flutes
00781203	3.0	6.0	2.8	50.0	5.0	10.0	1
00781204	4.0	6.0	3.8	50.0	6.0	6.0	2
00781206	6.0	6.0	5.6	50.0	10.0	14.0	2
00781208	8.0	8.0	7.2	50.0	12.0	16.0	2
00781210	10.0	10.0	9.2	60.0	8.0	17.0	2

DATRON

Face milling tool

Single flute end mill, stepped	42
Double flute end mill, stepped	43
Double flute end mill, stepped and edge radius	44
Double flute end mill, stepped with edge radius and polished flute for acrylic glass	45
Face milling tool/monoblock	46



DATRON

Single flute end mill stepped and balanced



Aluminium

Copper

Wood



Brass

Plastic



Item no.	D1 (mm)	D2 (mm)	L1 (mm)	L2 (mm)
0068812G	12.0	6.0	45.0	5.0
0068814E	14.0	8.0	45.0	5.0
0068820E	20.0	10.0	50.0	7.0
0068824E	24.0	12.0	60.0	8.5

DATRON

Item no.	D1 (mm)	D2 (mm)	L1 (mm)	L2 (mm)
0068814E	14	8	45	5

Double flute end mill stepped

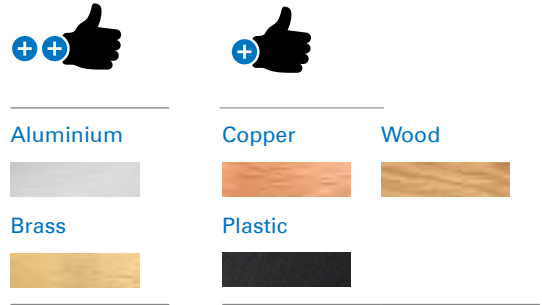
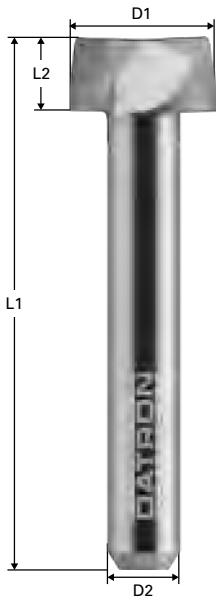

6 mm shank

Item no.	D1 (mm)	D2 (mm)	L1 (mm)	L2 (mm)
0068441	8.0	6.0	50.0	10.0
0068440	10.0	6.0	50.0	10.0
0068442G	12.0	6.0	50.0	6.0
0068442A	14.0	6.0	50.0	6.0

8 mm shank

Item no.	D1 (mm)	D2 (mm)	L1 (mm)	L2 (mm)
0068443G	14.0	8.0	50.0	6.0
0068444G	20.0	8.0	50.0	8.0

10 mm shank

Item no.	D1 (mm)	D2 (mm)	L1 (mm)	L2 (mm)
0078812A	12.0	10.0	50.0	10.0
0078814A	14.0	10.0	50.0	10.0
0078816A	16.0	10.0	50.0	10.0
0078816B	16.0	10.0	82.0	12.0
0078818A	18.0	10.0	50.0	10.0
0078820A	20.0	10.0	50.0	10.0

12 mm shank

Item no.	D1 (mm)	D2 (mm)	L1 (mm)	L2 (mm)
0078814	14.0	12.0	50.0	10.0
0078816	16.0	12.0	50.0	10.0
0078818	18.0	12.0	50.0	10.0
0078820	20.0	12.0	50.0	10.0

DATRON NEO

Item no.	D1 (mm)	D2 (mm)	L1 (mm)	L2 (mm)
0078808	8	8	60	10
0078808R	8	8	60	12
0068443G	14	8	50	6

DATRON

Double flute end mill stepped and edge radius

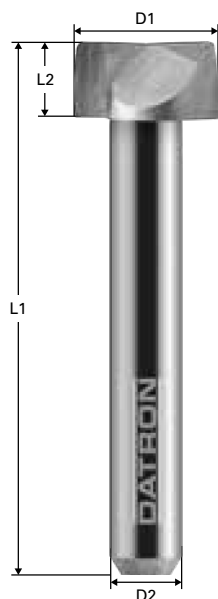

Aluminium

Copper

Wood



Brass

Plastic



Item no.	D1 (mm)	D2 (mm)	L1 (mm)	L2 (mm)	R (mm)
0068442	12.0	6.0	50.0	6.0	0.5
0068442N	12.0	8.0	50.0	6.0	0.5
0068443	14.0	8.0	50.0	6.0	0.5
0068444	20.0	8.0	50.0	8.0	0.5

DATRON **neo**

Item no.	D1 (mm)	D2 (mm)	L1 (mm)	L2 (mm)	R (mm)
0068080K	8	8	50	12	1
0068442N	12	8	50	6	0.5
0068443	14	8	50	6	0.5

Double flute end mill stepped with edge radius and polished flute for acrylic glass



Acrylic glass



Plastic



6 mm shank

Item no.	D1 (mm)	D2 (mm)	L1 (mm)	L2 (mm)	R (mm)
0078440	10.0	6.0	50.0	6.0	1.0
0078442	12.0	6.0	50.0	6.0	1.0

8 mm shank

Item no.	D1 (mm)	D2 (mm)	L1 (mm)	L2 (mm)	R (mm)
0078444	14.0	8.0	50.0	6.0	1.0
0078446	16.0	8.0	50.0	6.0	1.0

DATRON neo

Item no.	D1 (mm)	D2 (mm)	L1 (mm)	L2 (mm)	R (mm)
0078444	14	8	50	6	1

DATRON

Face milling tool/monoblock

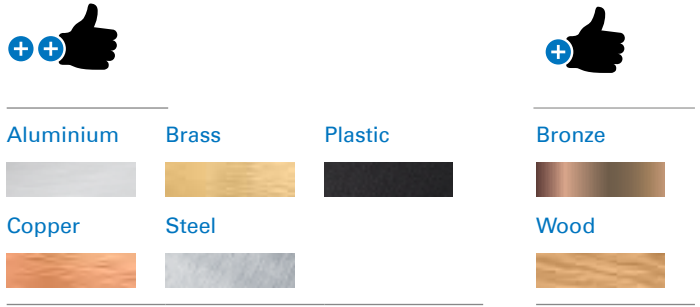

Item no.	Type	D1 (mm)	D3 (mm)	L1 (mm)	L2 (mm)
0078920*	HSK-E-25	20.0	18.5	40.0	10.0
0078920L*	HSK-E-25	20.0	18.5	60.0	10.0
0078924*	HSK-E-32	24.0	22.5	45.0	10.0
0078924L*	HSK-E-32	24.0	22.5	65.0	10.0

Item no.	Item name	For MLCube	Material	R (mm)
0078920A	Indexable insert, polished	0078920 / 20L / 24 / 24L	Aluminium	0.8
0078920B	Indexable insert	0078920 / 20L / 24 / 24L	Steel	0.8

Item no.	Item name
0078920C	Screw set with 10 screws and screwdriver

Note: only in combination with a measurable DATRON tool length sensor

* Monoblock basic tool without indexable inserts. Please specify which indexable inserts are required when ordering!

DATRON

Ball nose end mill

Ball nose end mill, one flute	48
Ball nose end mill, one flute and polished for acrylic glass	49
Ball nose end mill, two flutes	50
Ball nose end mill, two flutes with toric cut	51
Ball nose end mill, two flutes with coating (ALCRONA)	52
Ball nose end mill, four flutes with coating (ALCRONA)	53



DATRON

Ball nose end mill one flute

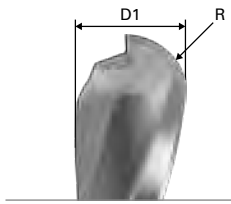
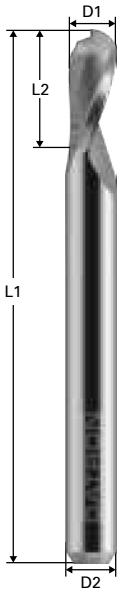

Aluminium



Plastic



Wood



Bronze



Brass



Item no.	D1 (mm)	D2 (mm)	L1 (mm)	L2 (mm)	R (mm)
0068171E	1.0	3.0	40.0	4.0	0.5
0068172E	2.0	6.0	50.0	7.0	1.0
0068173E	3.0	6.0	50.0	8.0	1.5
0068174E	4.0	6.0	50.0	10.0	2.0
0068175E	5.0	6.0	50.0	12.0	2.5
0068176E	6.0	6.0	50.0	14.0	3.0
0068178E	8.0	8.0	60.0	14.0	4.0
0068179E	10.0	10.0	60.0	20.0	5.0

Ball nose end mill one flute, polished for acrylic glass

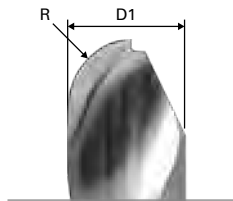
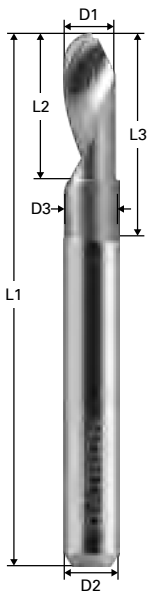

Acrylic glass



Plastic



6 mm shank

Item no.	D1 (mm)	D2 (mm)	D3 (mm)	L1 (mm)	L2 (mm)	L3 (mm)	R (mm)
0068191E	1.0	6.0	0.9	50.0	4.0	12.0	0.5
0068191S	1.5	6.0	1.4	50.0	5.0	12.0	0.75
0068192E	2.0	6.0	1.8	50.0	6.0	20.0	1.0
0068192S	2.5	6.0	2.3	50.0	7.0	20.0	1.25
0068193E	3.0	6.0	2.8	50.0	8.0	21.0	1.5
0068194E	4.0	6.0	3.8	50.0	10.0	21.0	2.0
0068195E	5.0	6.0	4.8	50.0	12.0	22.0	2.5
0068196E	6.0	6.0	5.8	50.0	14.0	22.0	3.0

DATRON

Ball nose end mill two flutes

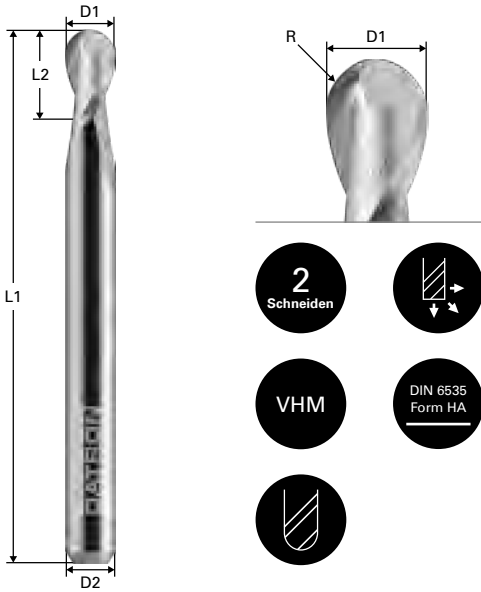

Item no.	D1 (mm)	D2 (mm)	L1 (mm)	L2 (mm)	R (mm)
00684003	0.3	3.0	40.0	0.5	0.15
00684005	0.5	3.0	39.0	0.8	0.25
00684007	0.7	3.0	39.0	2.1	0.35
0068400	1.0	3.0	38.0	3.0	0.5
0068403	3.0	6.0	50.0	4.0	1.5
0068404	4.0	6.0	50.0	5.0	2.0
0068405	5.0	6.0	50.0	5.0	2.5
0068406	6.0	6.0	50.0	10.0	3.0
0068408	8.0	8.0	50.0	12.0	4.0

Ball nose end mill two flutes with toric cut

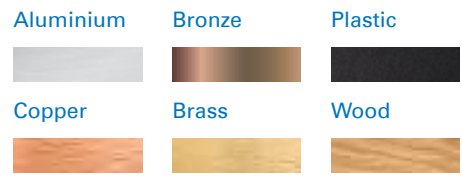
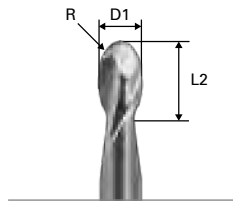
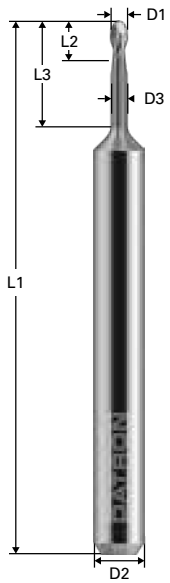

Item no.	D1 (mm)	D2 (mm)	D3 (mm)	L1 (mm)	L2 (mm)	L3 (mm)	R (mm)
00782004	0.4	3.0	0.35	39.0	0.6	2.0	0.2
00782005	0.5	3.0	0.45	39.0	0.75	4.0	0.25
00782006	0.6	3.0	0.55	39.0	0.9	4.0	0.3
00782008	0.8	3.0	0.75	39.0	1.2	6.0	0.4
00782010	1.0	3.0	0.95	39.0	1.5	6.0	0.5
00782011	1.0	3.0	0.95	39.0	1.5	9.0	0.5
00782012	1.2	3.0	1.15	39.0	1.8	9.0	0.6
00782015	1.5	3.0	1.45	39.0	2.2	9.0	0.75
00782020	2.0	3.0	1.95	39.0	3.0	12.0	1.0
0078502	2.0	6.0	1.8	75.0	5.0	20.0	1.0
0078503	3.0	6.0	2.8	75.0	6.0	20.0	1.5
0078504	4.0	6.0	3.8	75.0	8.0	20.0	2.0
0078505	5.0	6.0	4.8	100.0	20.0	40.0	2.5
0078506	6.0	6.0	5.8	100.0	20.0	40.0	3.0
0078508	8.0	8.0	7.8	100.0	20.0	40.0	4.0
0078510	10.0	10.0	9.8	100.0	20.0	40.0	5.0
0078512	12.0	12.0	11.7	100.0	20.0	40.0	6.0

DATRON

Ball nose end mill two flutes with coating (ALCRONA)

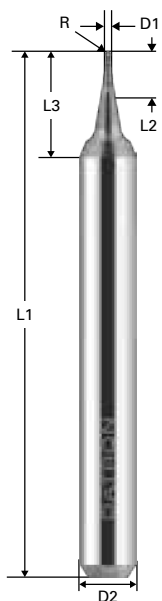

Steel

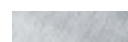

3 mm shank

Item no.	D1 (mm)	D2 (mm)	L1 (mm)	L2 (mm)	R (mm)
00684004	0.4	3.0	39.0	1.2	0.2
00684010	0.5	3.0	39.0	1.5	0.25
00684006	0.6	3.0	39.0	1.8	0.3
00684008	0.8	3.0	38.0	2.4	0.4
00684015	1.5	3.0	38.0	3.0	0.75
0068402	2.0	3.0	38.0	4.0	1.0
00684025	2.5	3.0	38.0	5.0	1.25
0068401	3.0	3.0	38.0	6.0	1.5

Ball nose end mill four flutes with coating (ALCRONA)

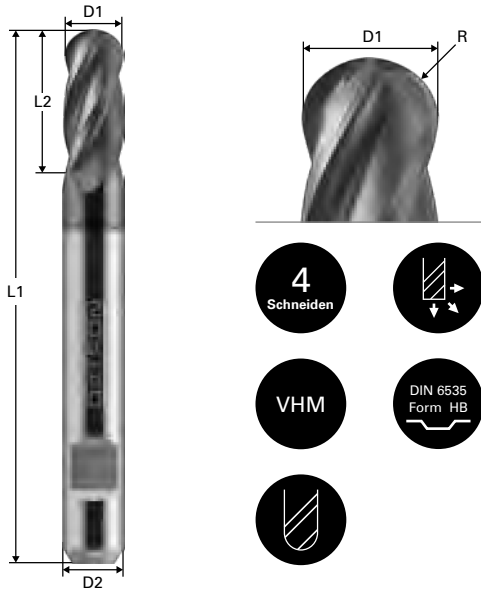

Steel

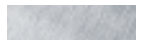

6 mm shank

Item no.	D1 (mm)	D2 (mm)	L1 (mm)	L2 (mm)	R (mm)
0078542	2.0	6.0	57.0	6.0	1.0
0078543	3.0	6.0	57.0	8.0	1.5
0078543A	3.0	6.0	57.0	20.0	1.5
0078544	4.0	6.0	57.0	11.0	2.0
0078544A	4.0	6.0	57.0	20.0	2.0
0078545	5.0	6.0	57.0	13.0	2.5
0078545A	5.0	6.0	75.0	30.0	2.5
0078546	6.0	6.0	57.0	13.0	3.0
0078546A	6.0	6.0	75.0	30.0	3.0

8 mm shank

Item no.	D1 (mm)	D2 (mm)	L1 (mm)	L2 (mm)	R (mm)
0078548	8.0	8.0	63.0	19.0	4.0
0078548A	8.0	8.0	75.0	30.0	4.0

10 mm shank

Item no.	D1 (mm)	D2 (mm)	L1 (mm)	L2 (mm)	R (mm)
0078550	10.0	10.0	72.0	22.0	5.0
0078550A	10.0	10.0	75.0	30.0	5.0

12 mm shank

Item no.	D1 (mm)	D2 (mm)	L1 (mm)	L2 (mm)	R (mm)
0078552	12.0	12.0	83.0	26.0	6.0
0078552A	12.0	12.0	100.0	45.0	6.0

DATRON

Toric end mill

Double flute end mill with edge radius	56
Double flute end mill with edge radius and coating (Triple-Cut)	57
Four flute end mill with edge radius and coating (X.CEED)	58
Four flute end mill with double radius and coating (X.CEED)	59



DATRON

Double flute end mill with edge radius



Aluminium



Brass



Copper



Wood



Plastic



6 mm shank

Item no.	D1 (mm)	D2 (mm)	D3 (mm)	L1 (mm)	L2 (mm)	L3 (mm)	R (mm)
0068460S	6.0	6.0		50.0	6.0		0.5
0068460F	6.0	6.0	5.8	58.0	7.0	21.0	1.0

8 mm shank

Item no.	D1 (mm)	D2 (mm)	D3 (mm)	L1 (mm)	L2 (mm)	L3 (mm)	R (mm)
0068080K	8.0	8.0		50.0	12.0		1.0
0078808R	8.0	8.0	7.7	60.0	10.0	22.0	0.2
0068080	8.0	8.0	7.8	60.0	9.0	23.0	1.0

Double flute end mill with edge radius and coating (Triple-Cut)

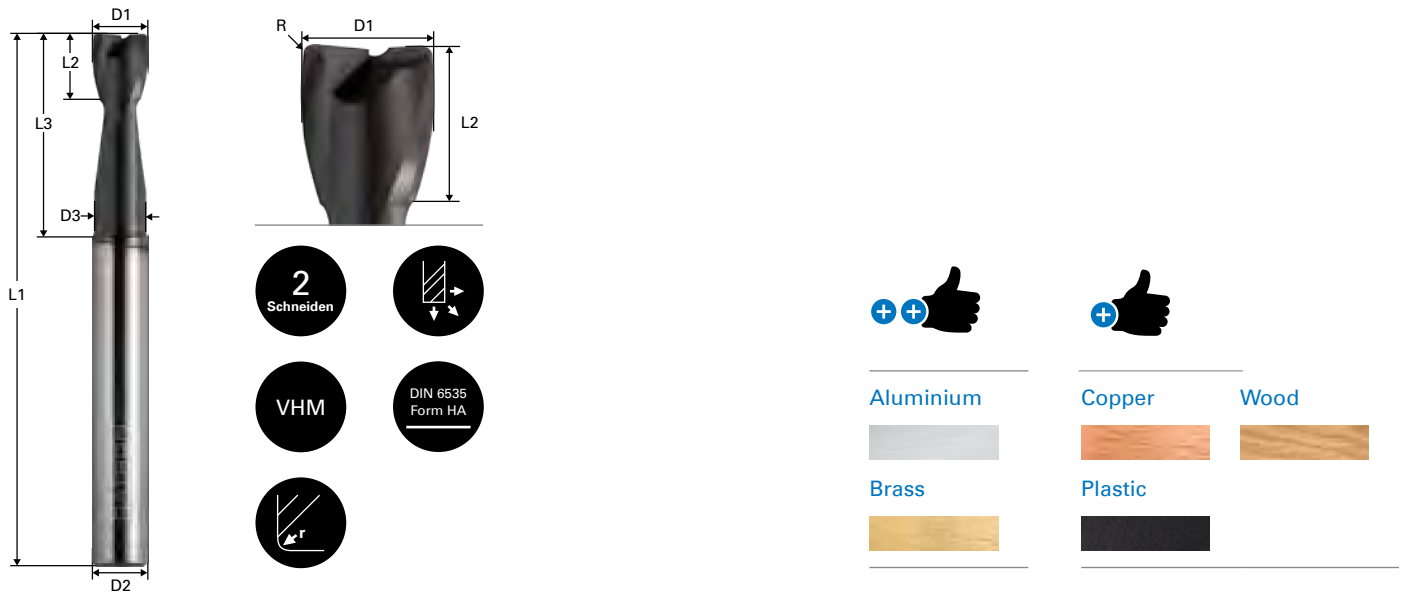

3 mm shank

Item no.	D1 (mm)	D2 (mm)	D3 (mm)	L1 (mm)	L2 (mm)	L3 (mm)	R (mm)
00781043	3.0	3.0	2.7	50.0	4.0	14.0	0.3
00781063	3.0	3.0	2.7	50.0	4.0	14.0	1.0

4 mm shank

Item no.	D1 (mm)	D2 (mm)	D3 (mm)	L1 (mm)	L2 (mm)	L3 (mm)	R (mm)
00781044	4.0	4.0	3.7	50.0	5.0	16.0	0.4
00781064	4.0	4.0	3.7	50.0	5.0	16.0	1.0

5 mm shank

Item no.	D1 (mm)	D2 (mm)	D3 (mm)	L1 (mm)	L2 (mm)	L3 (mm)	R (mm)
00781045	5.0	5.0	4.6	54.0	6.0	18.0	0.5
00781065	5.0	5.0	4.6	54.0	6.0	18.0	1.0

6 mm shank

Item no.	D1 (mm)	D2 (mm)	D3 (mm)	L1 (mm)	L2 (mm)	L3 (mm)	R (mm)
00781046	6.0	6.0	5.5	58.0	7.0	21.0	0.5
00781066	6.0	6.0	5.5	58.0	7.0	21.0	1.0

8 mm shank

Item no.	D1 (mm)	D2 (mm)	D3 (mm)	L1 (mm)	L2 (mm)	L3 (mm)	R (mm)
00781048	8.0	8.0	7.4	63.0	9.0	27.0	0.5
00781068	8.0	8.0	7.4	63.0	9.0	27.0	1.0

10 mm shank

Item no.	D1 (mm)	D2 (mm)	D3 (mm)	L1 (mm)	L2 (mm)	L3 (mm)	R (mm)
00781050	10.0	10.0	9.2	72.0	11.0	32.0	0.5
00781070	10.0	10.0	9.2	72.0	11.0	32.0	1.0

DATRON

Four flute end mill with edge radius and coating (X.CEED)



Steel



6 mm shank

Item no.	D1 (mm)	D2 (mm)	D3 (mm)	L1 (mm)	L2 (mm)	L3 (mm)	R (mm)
0078620	2.0	6.0	1.8	50.0	4.0	12.0	0.2
0078620A	2.0	6.0	1.8	50.0	4.0	16.0	0.2
0078623	3.0	6.0	2.7	50.0	4.0	14.0	0.3
0078623A	3.0	6.0	2.7	50.0	4.0	18.0	0.3
0078624	4.0	6.0	3.7	50.0	5.0	16.0	0.4
0078625	5.0	6.0	4.6	54.0	6.0	18.0	0.5
0078625A	5.0	6.0	4.6	54.0	6.0	18.0	1.0
0078626	6.0	6.0	5.5	57.0	7.0	21.0	0.5
0078626A	6.0	6.0	5.5	57.0	7.0	21.0	1.0

8 mm shank

Item no.	D1 (mm)	D2 (mm)	D3 (mm)	L1 (mm)	L2 (mm)	L3 (mm)	R (mm)
0078628	8.0	8.0	7.4	63.0	9.0	27.0	0.5
0078628A	8.0	8.0	7.4	63.0	9.0	27.0	1.0

10 mm shank

Item no.	D1 (mm)	D2 (mm)	D3 (mm)	L1 (mm)	L2 (mm)	L3 (mm)	R (mm)
0078630	10.0	10.0	9.2	72.0	11.0	32.0	0.5
0078630A	10.0	10.0	9.2	72.0	11.0	32.0	1.0

Four flute end mill with double radius and coating (X.CEED)

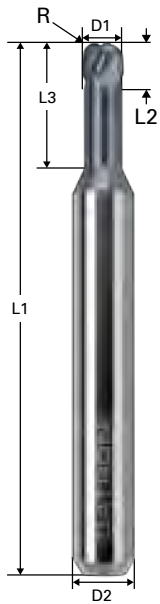

Steel



6 mm shank

Item no.	D1 (mm)	D2 (mm)	L1 (mm)	L2 (mm)	R (mm)
00686903	3.0	6.0	50.0	1.0	0.8
00686904	4.0	6.0	50.0	1.0	0.8
00686906	6.0	6.0	50.0	1.0	0.8

DATRON

Chamfer mill

Chamfer mill 62

Chamfer mill for acrylic glass 63

Chamfer mill for foam 64

Milling countersink tool 65

V-slot milling tool 66



DATRON

Chamfer mill

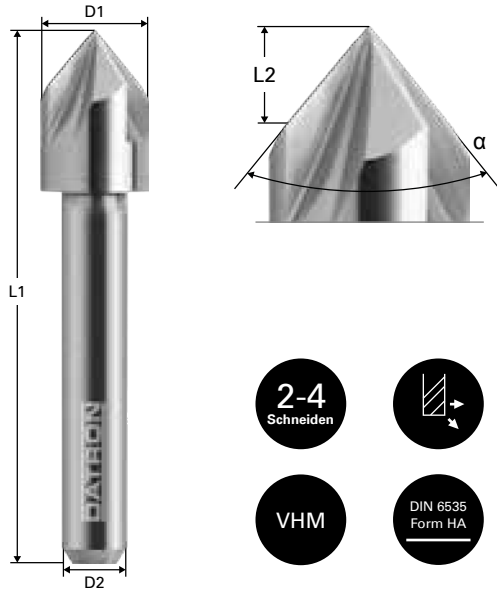

Aluminium

Wood

Bronze



Plastic



Brass



Item no.	D1 (mm)	D2 (mm)	L1 (mm)	L2 (mm)	α (°)	Number of flutes
0068478A	3.0	3.0	40.0	2.5	60	2
0068478	3.0	3.0	40.0	1.5	90	2
0068479B	6.0	6.0	50.0	8.2	40	3
0068480B	6.0	6.0	50.0	5.1	60	4
0068479C	6.0	6.0	50.0	4.2	70	3
0068479	6.0	6.0	50.0	3.0	90	3
0068479A	6.0	6.0	50.0	1.7	120	4
0068479D	6.0	6.0	50.0	1.1	140	3
0068479E	6.0	6.0	50.0	1.2	160	3
0068480	8.0	6.0	50.0	4.0	90	3
0068480C	8.0	6.0	50.0	3.3	100	4
0068480A	8.0	6.0	50.0	2.3	120	3
0068483	10.0	6.0	50.0	5.0	90	3
0068483A	10.0	6.0	50.0	2.8	120	4
0068483E	12.0	6.0	50.0	3.4	120	4
0068483D	12.0	8.0	50.0	6.0	90	4
0068483H	14.0	8.0	50.0	7.0	90	4
0068483B	10.0	10.0	50.0	5.0	90	3

DATRON

Item no.	D1 (mm)	D2 (mm)	L1 (mm)	L2 (mm)	α (°)	Number of flutes
0068480N	8	8	50	4	90	3
0068483N	10	8	50	5	90	3
0068483D	12	8	50	4	90	4
0068483H	14	8	50	7	90	4

Chamfer mill for acrylic glass

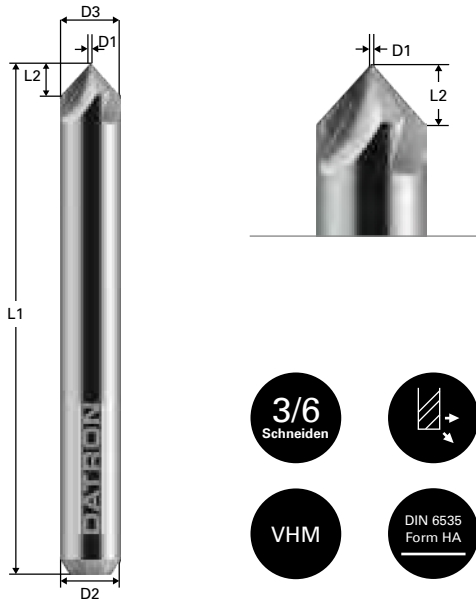

Acrylic glass



Plastic



6 mm shank

Item no.	D1 (mm)	D2 (mm)	D3 (mm)	L1 (mm)	L2 (mm)	α (°)	Number of flutes
00685806	0.1	6.0	6.0	50.0	3.0	90	6
00685808	0.1	6.0	8.0	50.0	4.0	90	6
00685810	4.0	6.0	10.0	50.0	3.0	90	3
00685812	4.0	6.0	12.0	50.0	4.0	90	3
00685814	4.0	6.0	14.0	50.0	5.0	90	3
00685816	4.0	6.0	16.0	50.0	6.0	90	3

DATRON

Chamfer mill for foam

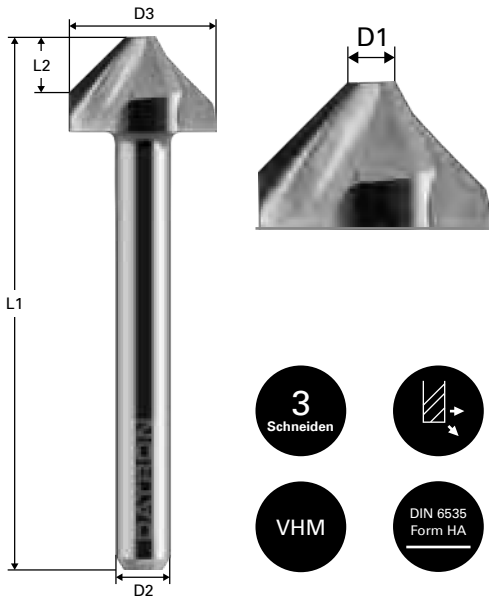

Foams



6 mm shank

Item no.	D1 (mm)	D2 (mm)	D3 (mm)	L1 (mm)	L2 (mm)	α (°)
0068485C	4.0	6.0	10.0	50.0	3.0	90
0068485D	4.0	6.0	12.0	50.0	4.0	90
0068485E	4.0	6.0	14.0	50.0	5.0	90
0068485F	4.0	6.0	16.0	50.0	6.0	90

DATRON *neo*

Item no.	D1 (mm)	D2 (mm)	D3 (mm)	L1 (mm)	L2 (mm)	α (°)
0068485N	4	8	14	50	5	90

Milling countersink tool



Aluminium

Wood

Bronze



Plastic

Brass



6 mm shank

Item no.	D1 (mm)	D2 (mm)	L1 (mm)	L2 (mm)	α (°)
0068772D	2.0	6.0	50.0	1.0	90
0068772E	2.0	6.0	50.0	1.5	90
0068772	2.0	6.0	50.0	1.9	90
0068772F	2.0	6.0	50.0	2.5	90
0068772A	2.0	6.0	50.0	2.9	90
0068772G	2.0	6.0	50.0	4.0	90
0068772B	2.0	6.0	50.0	4.9	90
0068773D	3.0	6.0	50.0	1.0	90
0068773E	3.0	6.0	50.0	1.5	90
0068773G	3.0	6.0	50.0	2.0	90
0068773F	3.0	6.0	50.0	2.5	90
0068773	3.0	6.0	50.0	2.9	90
0068773A	3.0	6.0	50.0	3.9	90
0068773B	3.0	6.0	50.0	4.9	90
0068774D	4.0	6.0	50.0	1.0	90
0068774E	4.0	6.0	50.0	1.5	90
0068774G	4.0	6.0	50.0	2.0	90
0068774F	4.0	6.0	50.0	2.5	90
0068774	4.0	6.0	50.0	2.9	90
0068774A	4.0	6.0	50.0	3.9	90
0068774B	4.0	6.0	50.0	5.0	90
0068775D	5.0	6.0	50.0	1.0	90
0068775E	5.0	6.0	50.0	1.5	90
0068775G	5.0	6.0	50.0	2.0	90
0068775F	5.0	6.0	50.0	2.5	90
0068775	5.0	6.0	50.0	3.0	90
0068775A	5.0	6.0	50.0	4.0	90
0068775B	5.0	6.0	50.0	5.0	90

DATRON

V-slot mill

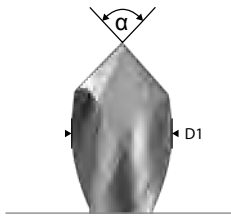
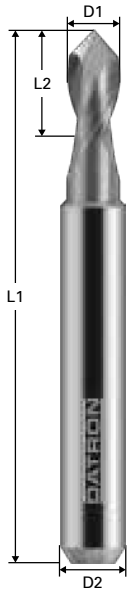

Aluminium

Wood



Bronze



Plastic



Brass



6 mm shank

Item no.	D1 (mm)	D2 (mm)	L1 (mm)	L2 (mm)	α (°)
0068795A	5	6	50	10	60
68795	5	6	50	10	90
0068795B	5	6	50	10	120
0068796A	6	6	58	12	60
68796	6	6	58	12	90
0068796B	6	6	58	12	120

8 mm shank

Item no.	D1 (mm)	D2 (mm)	L1 (mm)	L2 (mm)	α (°)
0068798A	8	8	70	16	60
68798	8	8	70	16	90
0068798B	8	8	70	16	120

10 mm shank

Item no.	D1 (mm)	D2 (mm)	L1 (mm)	L2 (mm)	α (°)
0068799A	10	10	70	16	60
68799	10	10	70	16	90
0068799B	10	10	70	16	120

DATRON

Drill

Drill, 3mm shank	68
Drill, 1/8" shank	70
Drill, 6mm shank	72

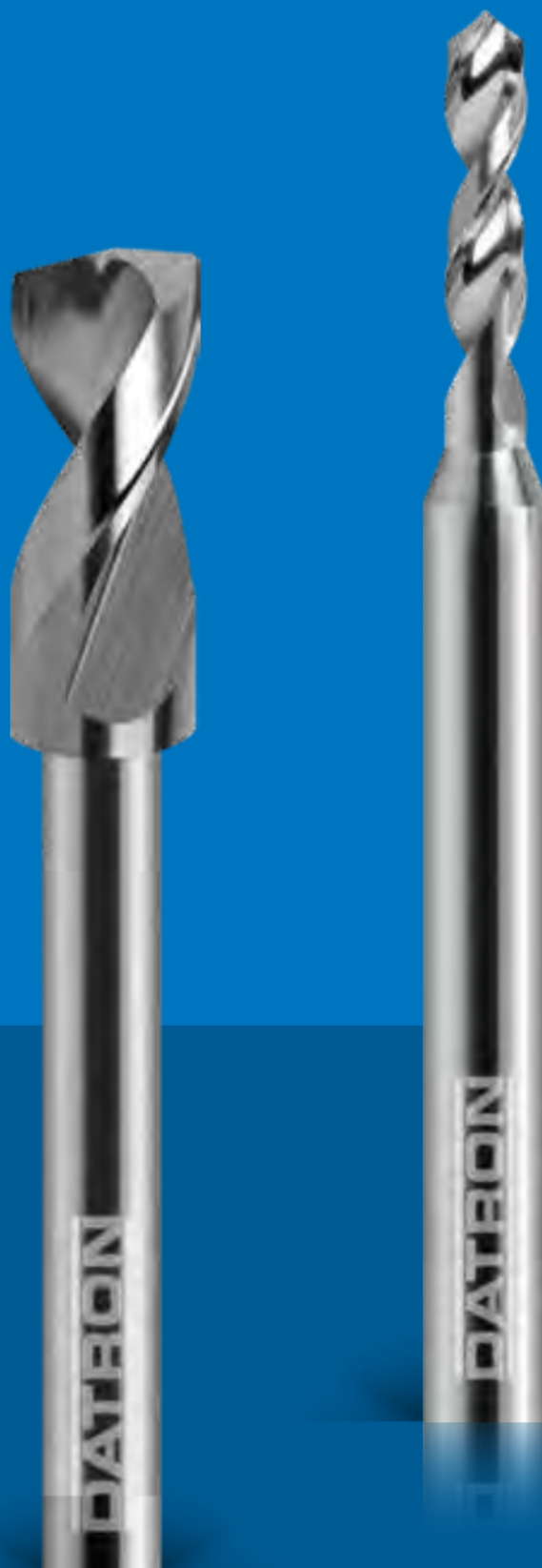

DATRON

Drill 3 mm shank

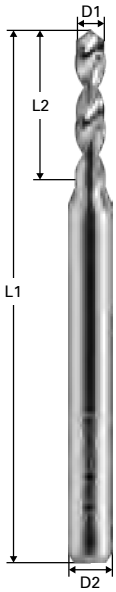

Aluminium



Bronze



Plastic



Steel



Copper



Brass



Wood



3 mm shank

Item no.	D1 (mm)	D2 (mm)	L1 (mm)	L2 (mm)
00682015	0.15	3.0	38.0	2.0
0068202	0.2	3.0	38.0	3.5
00682025	0.25	3.0	38.0	3.5
0068203	0.3	3.0	38.0	3.5
00682035	0.35	3.0	38.0	3.5
0068204	0.4	3.0	38.0	6.0
00682045	0.45	3.0	38.0	6.0
0068205	0.5	3.0	38.0	6.0
00682055	0.55	3.0	38.0	6.0
0068206	0.6	3.0	38.0	6.5
00682065	0.65	3.0	38.0	6.5
0068207	0.7	3.0	38.0	10.5
00682075	0.75	3.0	38.0	10.5
0068208	0.8	3.0	38.0	10.5
00682085	0.85	3.0	38.0	10.5
0068209	0.9	3.0	38.0	10.5
00682095	0.95	3.0	38.0	10.5
0068210	1.0	3.0	38.0	10.5
00682105	1.05	3.0	38.0	10.5
0068211	1.1	3.0	38.0	10.5
00682115	1.15	3.0	38.0	10.5
0068212	1.2	3.0	38.0	10.5
00682125	1.25	3.0	38.0	10.5
0068213	1.3	3.0	38.0	10.5
00682135	1.35	3.0	38.0	10.5
0068214	1.4	3.0	38.0	10.5
00682145	1.45	3.0	38.0	10.5
0068215	1.5	3.0	38.0	10.5
00682155	1.55	3.0	38.0	10.5
0068216	1.6	3.0	38.0	10.5
00682165	1.65	3.0	38.0	10.5
0068217	1.7	3.0	38.0	10.5
00682175	1.75	3.0	38.0	10.5
0068218	1.8	3.0	38.0	10.5

Item no.	D1 (mm)	D2 (mm)	L1 (mm)	L2 (mm)
00682185	1.85	3.0	38.0	10.5
0068219	1.9	3.0	38.0	10.5
00682195	1.95	3.0	38.0	10.5
0068220	2.0	3.0	38.0	10.5
00682205	2.05	3.0	38.0	10.5
0068221	2.1	3.0	38.0	10.5
00682215	2.15	3.0	38.0	10.5
0068222	2.2	3.0	38.0	10.5
00682225	2.25	3.0	38.0	10.5
0068223	2.3	3.0	38.0	10.5
00682235	2.35	3.0	38.0	10.5
0068224	2.4	3.0	38.0	10.5
00682245	2.45	3.0	38.0	10.5
0068225	2.5	3.0	38.0	10.5
00682255	2.55	3.0	38.0	10.5
0068226	2.6	3.0	38.0	10.5
00682265	2.65	3.0	38.0	10.5
0068227	2.7	3.0	38.0	10.5
00682275	2.75	3.0	38.0	10.5
0068228	2.8	3.0	38.0	10.5
00682285	2.85	3.0	38.0	10.5
0068229	2.9	3.0	38.0	10.5
00682295	2.95	3.0	38.0	10.5
0068230	3.0	3.0	38.0	10.5
0068231	3.1	3.0	38.0	12.0
0068232	3.2	3.0	38.0	12.0
0068233	3.3	3.0	38.0	12.0
0068234	3.4	3.0	38.0	12.0
0068235	3.5	3.0	38.0	12.0
0068236	3.6	3.0	38.0	12.0
0068237	3.7	3.0	38.0	12.0
0068238	3.8	3.0	38.0	12.0
0068239	3.9	3.0	38.0	12.0
0068240	4.0	3.0	38.0	12.0
0068241	4.1	3.0	38.0	12.0
0068242	4.2	3.0	38.0	12.0
0068243	4.3	3.0	38.0	12.0
0068244	4.4	3.0	38.0	12.0
0068245	4.5	3.0	38.0	12.0
0068246	4.6	3.0	38.0	12.0
0068247	4.7	3.0	38.0	12.0
0068248	4.8	3.0	38.0	12.0
0068249	4.9	3.0	38.0	12.0
0068250	5.0	3.0	38.0	12.0
0068251	5.1	3.0	38.0	12.0
0068252	5.2	3.0	38.0	12.0
0068253	5.3	3.0	38.0	12.0
0068254	5.4	3.0	38.0	12.0
0068255	5.5	3.0	38.0	12.0
0068256	5.6	3.0	38.0	12.0
0068257	5.7	3.0	38.0	12.0
0068258	5.8	3.0	38.0	12.0
0068259	5.9	3.0	38.0	12.0
0068260	6.0	3.0	38.0	12.0
0068261	6.1	3.0	38.0	12.0
0068262	6.2	3.0	38.0	12.0
0068263	6.3	3.0	38.0	12.0
0068264	6.4	3.0	38.0	12.0
0068265	6.5	3.0	38.0	12.0

DATRON

Drill 1/8" shank

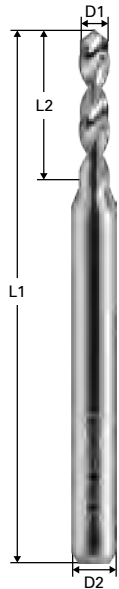

Aluminium



Bronze



Plastic



Steel



Copper



Brass



Wood



1/8" shank

Item no.	D1 (mm)	D2 (mm)	L1 (mm)	L2 (mm)
0068701	0.1	3175	38.0	1.0
00687015	0.15	3175	38.0	2.5
0068702	0.2	3175	38.0	3.2
00687025	0.25	3175	38.0	3.5
0068703	0.3	3175	38.0	5.5
00687035	0.35	3175	38.0	5.5
0068704	0.4	3175	38.0	5.5
00687045	0.45	3175	38.0	5.5
0068705	0.5	3175	38.0	5.5
00687055	0.55	3175	38.0	5.5
0068706	0.6	3175	38.0	7.0
00687065	0.65	3175	38.0	8.5
0068707	0.7	3175	38.0	10.5
00687075	0.75	3175	38.0	10.5
0068708	0.8	3175	38.0	10.5
00687085	0.85	3175	38.0	10.5
0068709	0.9	3175	38.0	10.5
00687095	0.95	3175	38.0	10.5
0068710	1.0	3175	38.0	10.5
00687105	1.05	3175	38.0	10.5
0068711	1.1	3175	38.0	10.5
00687115	1.15	3175	38.0	10.5
0068712	1.2	3175	38.0	10.5
00687125	1.25	3175	38.0	10.5
0068713	1.3	3175	38.0	10.5
00687135	1.35	3175	38.0	10.5
0068714	1.4	3175	38.0	10.5
00687145	1.45	3175	38.0	10.5
0068715	1.5	3175	38.0	10.5
00687155	1.55	3175	38.0	10.5
0068716	1.6	3175	38.0	10.5
00687165	1.65	3175	38.0	10.5
0068717	1.7	3175	38.0	10.5
00687175	1.75	3175	38.0	10.5
0068718	1.8	3175	38.0	10.5

Item no.	D1 (mm)	D2 (mm)	L1 (mm)	L2 (mm)
00687185	1.85	3175	38.0	10.5
0068719	1.9	3175	38.0	10.5
00687195	1.95	3175	38.0	10.5
0068720	2.0	3175	38.0	10.5
00687205	2.05	3175	38.0	10.5
0068721	2.1	3175	38.0	10.5
00687215	2.15	3175	38.0	10.5
0068722	2.2	3175	38.0	10.5
00687225	2.25	3175	38.0	10.5
0068723	2.3	3175	38.0	10.5
00687235	2.35	3175	38.0	10.5
0068724	2.4	3175	38.0	10.5
00687245	2.45	3175	38.0	10.5
0068725	2.5	3175	38.0	10.5
0068725X	2.5	3175	38.0	12.0
00687255	2.55	3175	38.0	10.5
0068726	2.6	3175	38.0	10.5
00687265	2.65	3175	38.0	10.5
0068727	2.7	3175	38.0	10.5
00687275	2.75	3175	38.0	10.5
0068728	2.8	3175	38.0	10.5
00687285	2.85	3175	38.0	10.5
0068729	2.9	3175	38.0	10.5
0068729X	2.9	3175	38.0	16.0
00687295	2.95	3175	38.0	10.5
0068730	3.0	3175	38.0	10.5
00687305	3.05	3175	38.0	10.5
0068731	3.1	3175	38.0	10.5
0068732	3.2	3175	38.0	12.0
0068733	3.3	3175	38.0	12.0
0068734	3.4	3175	38.0	12.0
0068735	3.5	3175	38.0	12.0
0068736	3.6	3175	38.0	12.0
0068737	3.7	3175	38.0	12.0
0068738	3.8	3175	38.0	12.0
0068739	3.9	3175	38.0	12.0
0068740	4.0	3175	38.0	12.0
0068741	4.1	3175	38.0	12.0
0068742	4.2	3175	38.0	12.0
0068743	4.3	3175	38.0	12.0
0068744	4.4	3175	38.0	12.0
0068745	4.5	3175	38.0	12.0
0068746	4.6	3175	38.0	12.0
0068747	4.7	3175	38.0	12.0
0068748	4.8	3175	38.0	12.0
0068749	4.9	3175	38.0	12.0
0068750	5.0	3175	38.0	12.0
0068751	5.1	3175	38.0	12.0
0068752	5.2	3175	38.0	12.0
0068753	5.3	3175	38.0	12.0
0068754	5.4	3175	38.0	12.0
0068755	5.5	3175	38.0	12.0
0068756	5.6	3175	38.0	12.0
0068757	5.7	3175	38.0	12.0
0068758	5.8	3175	38.0	12.0
0068759	5.9	3175	38.0	12.0
0068760	6.0	3175	38.0	12.0
0068761	6.1	3175	38.0	12.0
0068762	6.2	3175	38.0	12.0
0068763	6.3	3175	38.0	12.0
0068764	6.4	3175	38.0	12.0
0068765	6.5	3175	38.0	12.0

DATRON

Drill 6mm shank

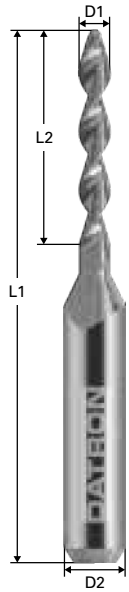

Aluminium



Bronze



Plastic



Wood



Copper



Brass



6 mm shank

Item no.	D1 (mm)	D2 (mm)	L1 (mm)	L2 (mm)
0068229X	2.9	6.0	50.0	21.0
0068230L	3.0	6.0	50.0	21.0
0068231L	3.1	6.0	50.0	21.0
0068232L	3.2	6.0	50.0	21.0
0068233L	3.3	6.0	50.0	21.0
0068234L	3.4	6.0	50.0	21.0
0068235L	3.5	6.0	50.0	21.0
0068236L	3.6	6.0	50.0	21.0
0068237L	3.7	6.0	50.0	21.0
0068238L	3.8	6.0	50.0	21.0
0068239L	3.9	6.0	50.0	21.0
0068239X	3.9	6.0	56.0	26.0
0068240L	4.0	6.0	50.0	21.0
0068240X	4.0	6.0	60.0	31.0
0068241L	4.1	6.0	50.0	21.0
0068242L	4.2	6.0	50.0	21.0
0068243L	4.3	6.0	50.0	21.0
0068244L	4.4	6.0	50.0	21.0
0068245L	4.5	6.0	50.0	21.0
0068245X	4.5	6.0	60.0	31.0
0068246L	4.6	6.0	50.0	21.0
0068247L	4.7	6.0	50.0	21.0
0068248L	4.8	6.0	50.0	21.0
0068249L	4.9	6.0	50.0	21.0
0068249X	4.9	6.0	60.0	31.0
0068250L	5.0	6.0	50.0	21.0
0068250X	5.0	6.0	60.0	31.0
0068251L	5.1	6.0	50.0	21.0
0068252L	5.2	6.0	50.0	21.0
0068253L	5.3	6.0	50.0	21.0
0068254L	5.4	6.0	50.0	21.0
0068255L	5.5	6.0	50.0	21.0
0068255X	5.5	6.0	60.0	31.0

Item no.	D1 (mm)	D2 (mm)	L1 (mm)	L2 (mm)
0068256L	5.6	6.0	50.0	21.0
0068257L	5.7	6.0	50.0	21.0
0068258L	5.8	6.0	50.0	21.0
0068259L	5.9	6.0	50.0	21.0
0068259X	5.9	6.0	70.0	36.0
0068260L	6.0	6.0	50.0	21.0
0068260X	6.0	6.0	60.0	31.0

DATRON

Reamer

Reamer

76



DATRON

Reamer

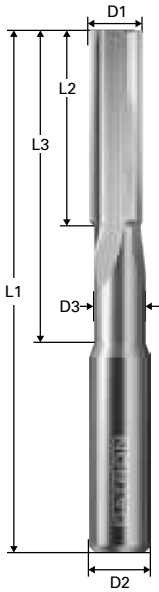

Aluminium



Copper



Brass



Bronze



DATRON Reamers Standard Version

Item no.	D1-Nom (mm)	D2 (mm)	D3 (mm)	L1 (mm)	L2 (mm)	L3 (mm)
0068103E	3H7	6	2.5	50	6	10
0068104E	4H7	6	3.3	50	8	12
0068105E	5H7	6	4.2	50	10	16
0068106E	6H7	6	5	55	12	21
0068108E	8H7	8	6.7	60	16	26
0068110E	10H7	10	8.3	65	20	31
0068112E	12H7	12	10	70	24	36

DATRON Reamers Long Version

Item no.	D1-Nom (mm)	D2 (mm)	D3 (mm)	L1 (mm)	L2 (mm)	L3 (mm)
0068103L	3H7	6	2.5	50	9	16
0068104L	4H7	6	3.3	55	12	21
0068105L	5H7	6	4.2	60	16	26
0068106L	6H7	6	5	65	21	31
0068108L	8H7	8	6.7	75	26	41
0068110L	10H7	10	8.3	85	31	51
0068112L	12H7	12	10	105	36	71

DATRON NEO

Item no.	D1-Nom (mm)	D2 (mm)	D3 (mm)	L1 (mm)	L2 (mm)	L3 (mm)
0068103N	3H7	8	2.5	50	6	10
0068104N	4H7	8	3.3	50	8	12
0068105N	5H7	8	4.2	50	10	16
0068106N	6H7	8	5	55	12	21
0068108E	8H7	8	6.7	60	16	26

A chamfer is required on the pilot hole to prevent swinging of the tool.

DATRON

Thread milling cutter

Parameters for thread milling cutter tool data 78

Thread whirler 80

Multi-thread whirler 81

Milling thread mill 82

Thread milling cutter 83



DATRON

Parameters for thread whirler tool data

Item no.	Speed	Feed	H/8	D1-Nom	D1-actual	D3	K	W/R	L2	Usable length	Pilot hole
00680010E	40000	150	0.027	0.720	0.750	0.320	40	60°	0.13	3.00	0.75
00680011E	40000	150	0.027	0.825	0.850	0.425	40	60°	0.13	3.00	0.85
00680012E	40000	150	0.027	0.840	0.880	0.440	40	60°	0.13	3.00	0.95
00680014E	40000	200	0.032	0.980	0.990	0.530	40	60°	0.15	4.00	1.10
00680016E	40000	200	0.038	1.120	1.150	0.610	40	60°	0.17	4.00	1.30
00680018E	40000	250	0.038	1.260	1.300	0.750	40	60°	0.17	4.00	1.50
00680020E	39000	250	0.043	1.400	1.440	0.830	40	60°	0.19	6.00	1.60
00680022E	39000	300	0.049	1.540	1.600	0.910	40	60°	0.21	6.00	1.80
00680025E	39000	300	0.049	1.750	1.800	1.120	40	60°	0.20	6.00	2.10
00680030E	38000	350	0.054	2.100	2.180	1.310	40	60°	0.26	8.00	2.50
00680035E	38000	350	0.065	2.450	2.500	1.550	40	60°	0.29	8.00	2.90
00680040E	37000	400	0.076	2.800	2.900	1.800	40	60°	0.33	11.00	3.30
00680045E	37000	400	0.081	3.150	3.200	2.100	40	60°	0.34	10.00	3.70
00680050E	36000	500	0.087	3.500	3.630	2.400	40	60°	0.36	10.00	4.20
00680060E	35000	600	0.108	4.200	4.380	2.900	40	60°	0.43	12.00	5.00
00680070E	35000	650	0.108	4.900	5.050	3.600	40	60°	0.43	14.00	6.00
00680080E	34000	700	0.135	5.600	5.810	4.050	40	60°	0.51	16.00	6.80
00680100E	32000	800	0.162	7.000	7.260	5.200	40	60°	0.57	21.00	8.50
00680120E	32000	850	0.189	8.400	8.700	6.350	40	60°	0.69	26.00	10.20

The specified actual values are intended for orientation and may vary under different conditions.

DATRON

Parameters for multi-thread whirler tool data

Item no.	Nom Dm (mm)	Act Dm (mm)	Speed (rpm)	K	D3 (mm)	W/R (°)	L2 (mm)
0068418/L	0.8	0.8	35000	40	0.49	60	0.09
0068418S	0.95	0.95	35000	40	0.49	60	0.09
0068419	1.4	1.4	35000	40	0.9	60	0.1
0068419L	1.4	1.4	30000	40	0.9	60	0.1
0068419X	1.4	1.4	32000	40	0.9	60	0.1
0068420	2	2	35000	40	1	60	0.2
0068420L	2	2	30000	40	1	60	0.2
0068420X	2	2	32000	40	1	60	0.2
0068451	4	4.08	25000	40	1	60	0.5
0068451L	4	4.08	22000	40	2	60	0.5
0068451X	4	4.08	24000	40	2	60	0.5
0068450	6	6	25000	40	3	55	0.7
0068452	6	5.95	25000	40	3	80	1.3
0068451A	8	8	25000	40	3	60	1.6
0068450A	8	8	25000	40	3	55	1.55

* Parameters for the multi-thread whirler are only applicable for HSC Pro and CNC VX.X. Parameters are not required for NEXT control system.

Parameters for milling thread mill tool data

Item no.	Nom Dm (mm)	Act Dm (mm)	Speed (rpm)	K	D3 (mm)	W/R (°)	L2 (mm)
0068419A	2.0	2.0	45000	40	1.34	60	0.2
0068420A	3.0	3.0	40000	40	1.97	60	0.3
0046454	6.0	5.95	33000	40	4.14	80	1.2
0068454A	6.0	5.95	33000	40	2.75	60	1.2
0068456	4.8	4.6	25000	40	3.35	60	0.5
0068457	6.0	5.95	25000	40	4.0	60	0.5
0068458	8.0	7.95	25000	40	5.4	60	0.5

* Parameters for the milling thread mill are only applicable for HSC Pro and CNC VX.X. Parameters are not required for NEXT control system.

Parameters for thread milling cutter tool data

Item no.	Nom Dm (mm)	Act Dm (mm)	Speed (rpm)	K	D3 (mm)	W/R (°)	L2 (mm)
00684503	2.3	2.3	21200	M3	0	60	0
00684544	3.0	2.98	14300	M4	0	60	0
00684555	3.8	3.72	12800	M5	0	60	0
00684566	4.5	4.48	10850	M6	0	60	0
00684568	6.1	6.0	8000	M8	0	60	0

* Parameters for the thread milling cutter are only applicable for HSC Pro and CNC VX.X. Parameters are not required for NEXT control system.

DATRON

Thread whirler

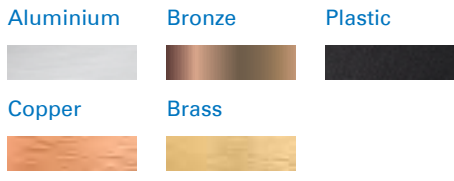
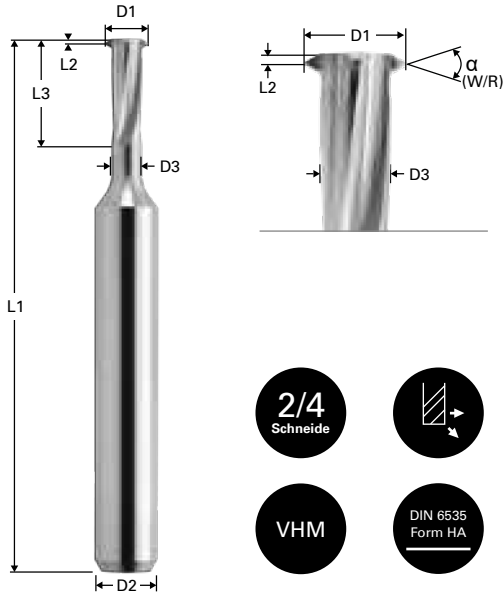

Thread whirler,

Item no.	Thread (M)	D1 (mm)	D2 (mm)	D3* (mm)	L1 (mm)	L2 (mm)	L3 (mm)	α (°)	Number of flutes	Pitch S	Pilot hole Ø
00680010E	M 1	0.720	3	0.320	40	0.13	3	60	2	0.25	0.75
00680011E	M 1.1	0.825	3	0.425	40	0.13	3	60	2	0.25	0.85
00680012E	M 1.2	0.840	3	0.440	40	0.13	3	60	2	0.25	0.95
00680014E	M 1.4	0.980	3	0.530	40	0.15	4	60	2	0.3	1.1
00680016E	M 1.6	1.120	3	0.610	40	0.17	4	60	2	0.35	1.3
00680018E	M 1.8	1.260	3	0.750	40	0.17	4	60	2	0.35	1.5
00680020E	M 2	1.400	3	0.830	40	0.19	6	60	2	0.4	1.6
00680022E	M 2.2	1.540	3	0.910	40	0.21	6	60	2	0.45	1.8
00680025E	M 2.5	1.750	3	1.120	40	0.2	6	60	4	0.45	2.1
00680030E	M 3	2.100	6	1.310	50	0.26	8	60	4	0.5	2.5
00680035E	M 3.5	2.450	6	1.550	50	0.29	8	60	4	0.6	2.9
00680040E	M 4	2.800	6	1.800	50	0.33	11	60	4	0.7	3.3
00680045E	M 4.5	3.150	6	2.100	50	0.34	10	60	4	0.75	3.7
00680050E	M 5	3.500	6	2.400	50	0.36	10	60	4	0.8	4.2
00680060E	M 6	4.200	6	2.900	50	0.43	12	60	4	1	5
00680070E	M 7	4.900	6	3.600	54	0.43	14	60	4	1	6
00680080E	M 8	5.600	6	4.050	58	0.51	16	60	4	1.25	6.8
00680100E	M 10	7.000	8	5.200	60	0.57	21	60	4	1.5	8.5
00680120E	M 12	8.400	10	6.350	66	0.69	26	60	4	1.75	10.2

* For both HSC pro and CNC VX.X the D3 information must be input at D2.

Multi-thread whirler

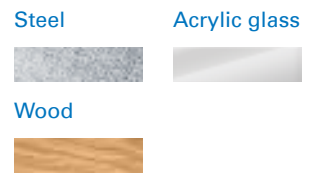
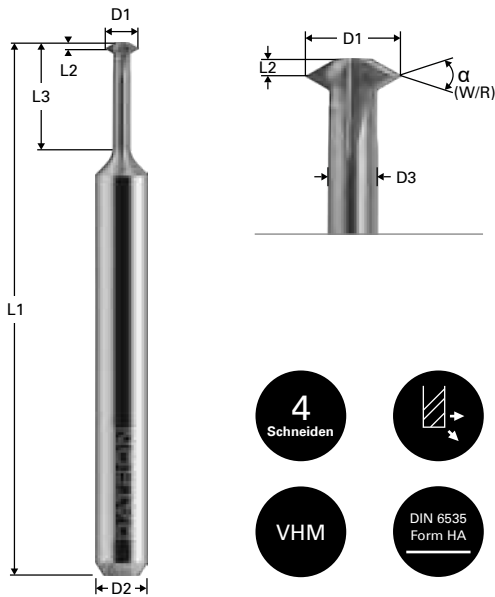

3 mm shank

Item no.	Thread	D1 (mm)	D2 (mm)	D3 (mm)	L1 (mm)	L2 (mm)	L3 (mm)	α (°)
0068418	M1.0 - M 1.2	0.8	3.0	0.49	40.0	0.09	3.0	60
0068418L	M1.0 - M 1.2	0.8	3.0	0.49	40.0	0.09	6.0	60
0068418S	M1.4	0.95	3.0	0.49	40.0	0.09	3.0	60
0068419	M1.6 - M2.5	1.4	3.0	0.9	40.0	0.1	6.0	60
0068419L	M1.6 - M2.5	1.4	3.0	0.9	40.0	0.1	10.0	60
0068419X	M1.6 - M2.5	1.4	3.0	0.9	60.0	0.1	6.0	60
0068420	M2.5 - M4	2.0	3.0	1.0	40.0	0.2	8.0	60
0068420L	M2.5 - M4	2.0	3.0	1.0	40.0	0.2	12.0	60
0068420X	M2.5 - M4	2.0	3.0	1.0	50.0	0.2	8.0	60

6 mm shank

Item no.	Thread	D1 (mm)	D2 (mm)	D3 (mm)	L1 (mm)	L2 (mm)	L3 (mm)	α (°)
0068451	M5 - M10	4.0	6.0	1.0	50.0	0.5	12.0	60
0068451L	M5 - M10	4.0	6.0	2.0	50.0	0.5	16.0	60
0068451X	M5 - M10	4.0	6.0	2.0	58.0	0.5	30.0	60
0068450	Whitworth ≤ 1/2"	6.0	6.0	3.0	50.0	0.7	12.0	55
0068452	PG7 - PG48	6.0	6.0	3.0	50.0	1.3	12.0	80
0068451A	M10 - M36	8.0	6.0	3.0	50.0	1.6	12.0	60
0068450A	Whitworth ≤ 1/2"	8.0	6.0	3.0	50.0	1.55	12.0	55

* For both HSC pro and CNC VX.X the D3 information must be input at D2.

DATRON

Milling thread mill



Aluminium

Plastic



Copper

Wood

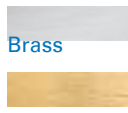

3 mm shank

Item no.	Thread	D1 (mm)	D2 (mm)	D3 (mm)	L1 (mm)	L2 (mm)	L3 (mm)	α (°)	Usable length (mm)
0068419A	M2.5 - M3	2.0	3.0	1.5	40.0	1.0	8.5	60	3
0068420A	M4 - M5	3.0	3.0	2.2	40.0	1.0	10.0	60	5

6 mm shank

Item no.	Thread	D1 (mm)	D2 (mm)	D3 (mm)	L1 (mm)	L2 (mm)	L3 (mm)	α (°)	Usable length (mm)
0068456	M6	3.6	6.0	3.4	50.0	1.0	12.0	60	6
0068457	M8 - M10	4.2	6.0	4.0	50.0	1.5	12.0	60	8
0068454A	met. screwed cable gland	4.2	6.0	4.0	50.0	2.0	12.0	60	10
0068454	PG7 - PG48	4.4	6.0	4.2	50.0	2.0	12.0	80	10
0068458	M12 - M16	5.6	6.0	5.4	50.0	1.5	12.0	60	10

Thread milling cutter

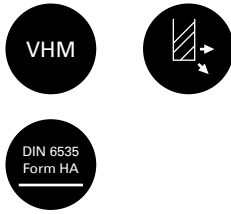

Aluminium Plastic



Brass



6 mm shank

Item no.	Thread	D1 (mm)	D2 (mm)	L1 (mm)	L2 (mm)	α (°)
00684503	M3	2.3	6.0	50.0	8.0	60
00684504	M4	3.0	6.0	50.0	8.0	60
00684544	M4	3.0	6.0	50.0	12.0	60
00684505	M5	3.8	6.0	50.0	12.0	60
00684555	M5	3.8	6.0	50.0	16.0	60

8 mm shank

Item no.	Thread	D1 (mm)	D2 (mm)	L1 (mm)	L2 (mm)	α (°)
00684506	M6	4.5	8.0	50.0	12.0	60
00684566	M6	4.5	8.0	50.0	16.0	60

10 mm shank

Item no.	Thread	D1 (mm)	D2 (mm)	L1 (mm)	L2 (mm)	α (°)
00684508	M8	6.0	10.0	50.0	12.0	60
00684588	M8	6.0	10.0	50.0	16.0	60

DATRON

External radius end mill

External radius end mill 86

External radius end mill, polished
for acrylic glass 87

Deburring miller, two flutes 88



DATRON

External radius end mill

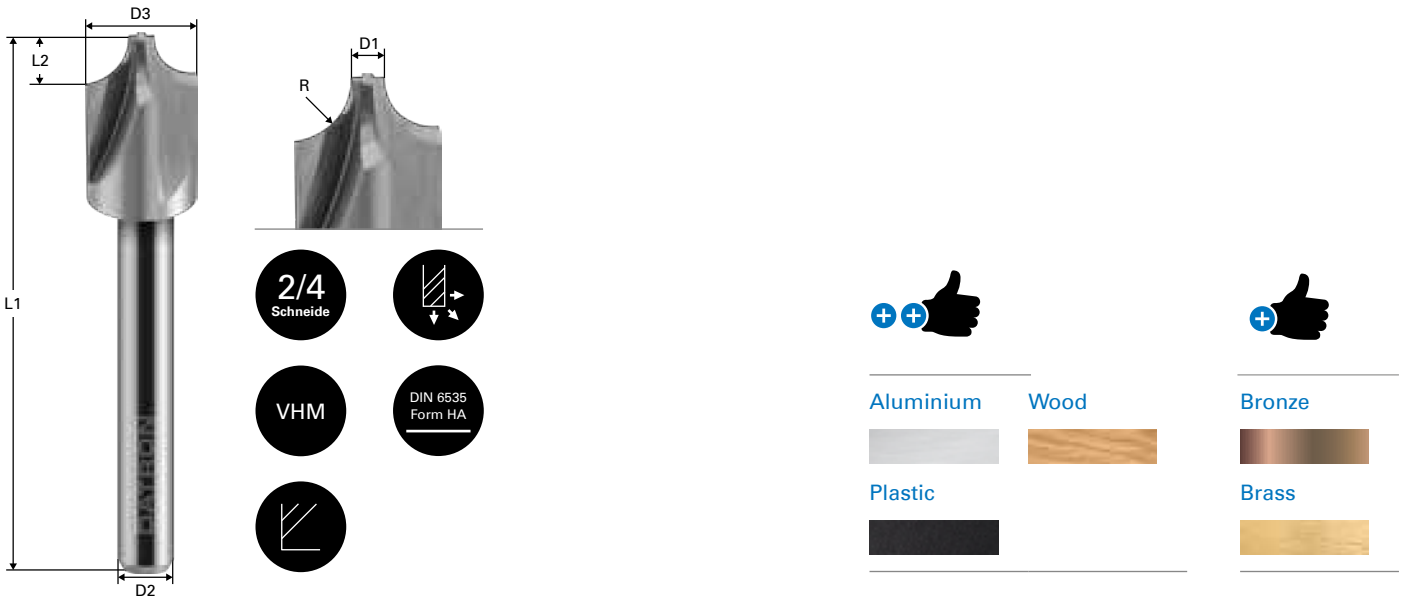

6 mm shank

Item no.	D1 (mm)	D2 (mm)	D3 (mm)	L1 (mm)	L2 (mm)	R (mm)	Number of flutes
0068412	2.0	6.0	6.0	50.0	2.0	2.0	2
00684115	3.0	6.0	6.0	50.0	1.5	1.5	2
00684125	3.0	6.0	8.0	50.0	2.5	2.5	4
00684145	3.0	6.0	12.0	50.0	4.5	4.5	4
0068415	3.0	6.0	13.0	50.0	5.0	5.0	4
0068411	4.0	6.0	6.0	50.0	1.0	1.0	2
0068413	4.0	6.0	10.0	50.0	3.0	3.0	4
00684135	4.0	6.0	11.0	50.0	3.5	3.5	4
0068414	4.0	6.0	12.0	50.0	4.0	4.0	4
0068416	4.0	6.0	16.0	50.0	6.0	6.0	4
0068410	5.0	6.0	6.0	50.0	0.5	0.5	2

8 mm shank

Item no.	D1 (mm)	D2 (mm)	D3 (mm)	L1 (mm)	L2 (mm)	R (mm)	Number of flutes
00684125N	3.0	8.0	8.0	50.0	2.5	2.5	4
00684135N	4.0	8.0	11.0	50.0	3.5	3.5	4
0068413N	4.0	8.0	10.0	50.0	3.0	3.0	4
0068414N	4.0	8.0	12.0	50.0	4.0	4.0	4

DATRON neo

Item no.	D1 (mm)	D2 (mm)	D3 (mm)	L1 (mm)	L2 (mm)	R (mm)	Number of flutes
00684125N	3	8	8	50	2.5	2.5	4
0068413N	4	8	10	50	3	3	4
00684135N	4	8	11	50	3.5	3.5	4
0068414N	4	8	12	50	4	4	4

External radius end mill polished for acrylic glass

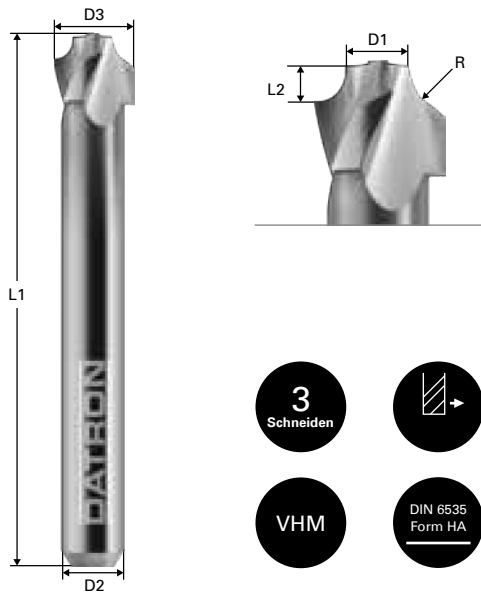

- 3**
Schneiden
-
- VHM
- DIN 6535
Form HA



Acrylic glass

Plastic

6 mm shank

Item no.	D1 (mm)	D2 (mm)	D3 (mm)	L1 (mm)	L2 (mm)	R (mm)
00685710	4.0	6.0	6.0	50.0	1.0	1.0
00685720	4.0	6.0	8.0	50.0	2.0	2.0
00685730	4.0	6.0	10.0	50.0	3.0	3.0
00685715	5.0	6.0	8.0	50.0	1.5	1.5
00685725	5.0	6.0	10.0	50.0	2.5	2.5

DATRON

Deburring miller two flutes



- 2**
Schneiden
-
- VHM
- DIN 6535
Form HA



Steel



3 mm shank

Item no.	D1 (mm)	D2 (mm)	L1 (mm)	L2 (mm)	R (mm)
00784908	0.8	3.0	40.0	0.3	0.3
00784909	0.9	3.0	40.0	0.3	0.3
00784910	1.0	3.0	40.0	0.3	0.3
00784911	1.1	3.0	40.0	0.3	0.3
00784912	1.2	3.0	40.0	0.3	0.3
00784913	1.3	3.0	40.0	0.3	0.3
00784914	1.4	3.0	40.0	0.3	0.3
00784915	1.5	3.0	40.0	0.3	0.3
00784916	1.6	3.0	40.0	0.3	0.3
00784917	1.7	3.0	40.0	0.3	0.3
00784918	1.8	3.0	40.0	0.3	0.3
00784919	1.9	3.0	40.0	0.3	0.3
00784920	2.0	3.0	40.0	0.3	0.3
00784921	2.1	3.0	40.0	0.3	0.3
00784922	2.2	3.0	40.0	0.3	0.3
00784923	2.3	3.0	40.0	0.3	0.3
00784924	2.4	3.0	40.0	0.3	0.3

DATRON

Standard engraving tool

Standard engraving tool	90
Standard engraving tool, balanced	92
Standard engraving tool for machining steel	93
Standard engraving tool for hard machining with coating (ALCRONA)	94

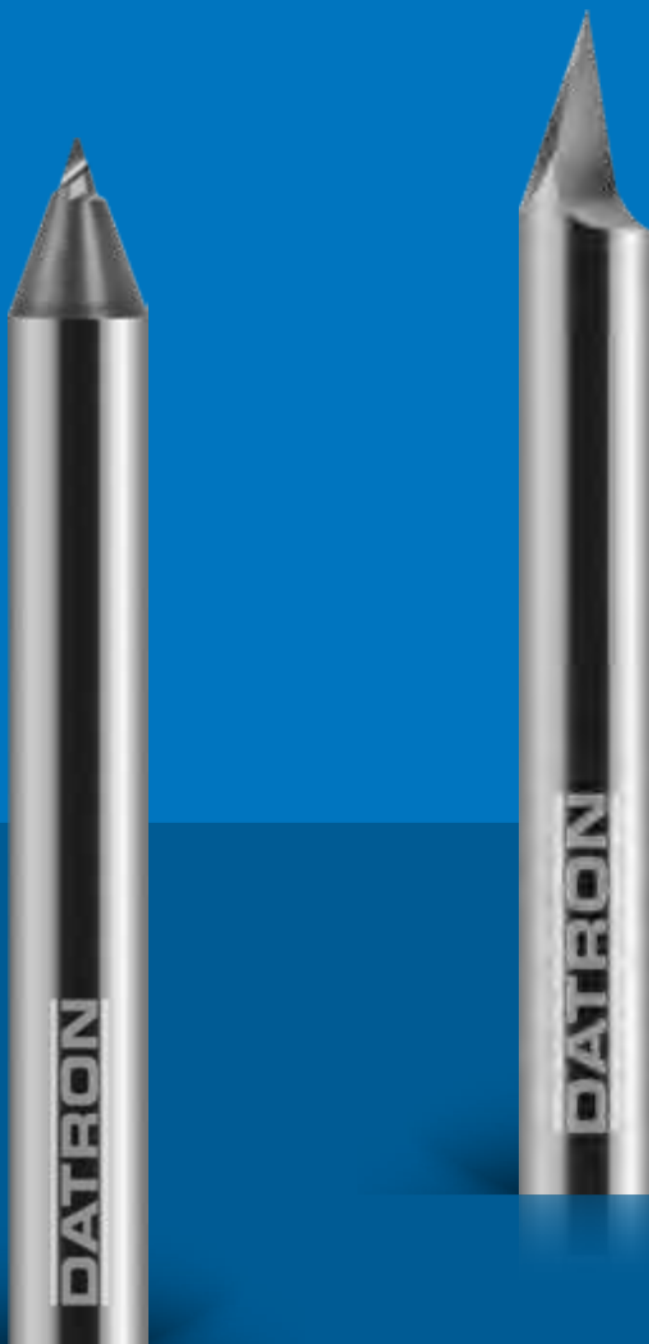

DATRON

Standard engraving tool

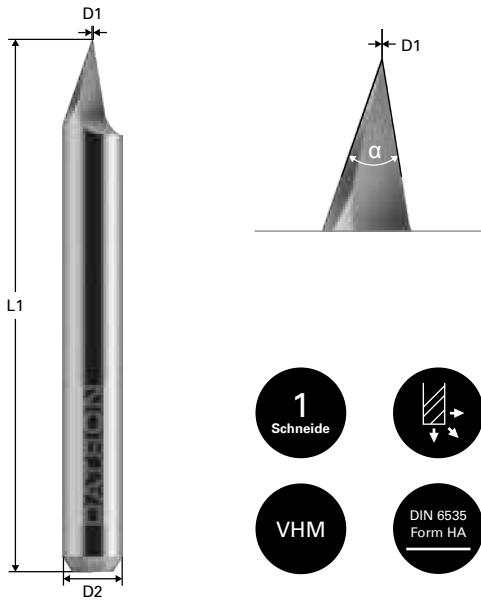

Aluminium

Bronze

Plastic

Wood



Copper

Brass

Acrylic glass



3 mm shank

Item no.	D1 (mm)	D2 (mm)	L1 (mm)	α (°)
0068278	0.05	3.0	40.0	20
0068279	0.1	3.0	40.0	20
0068279A	0.1	3.0	40.0	30
0068280	0.1	3.0	40.0	40
0068280A	0.1	3.0	40.0	45
0068281	0.1	3.0	40.0	60
0068282	0.1	3.0	40.0	90
0068278A	0.2	3.0	40.0	20
0068279B	0.2	3.0	40.0	30
0068280B	0.2	3.0	40.0	40
0068281A	0.2	3.0	40.0	60
0068280D	0.5	3.0	40.0	40
0068284	3.0	3.0	40.0	180

1/8" shank

Item no.	D1 (mm)	D2 (mm)	L1 (mm)	α (°)
0068679	0.1	3175	40.0	20
0068679A	0.1	3175	40.0	30
0068680	0.1	3175	40.0	40
0068681	0.1	3175	40.0	60
0068682	0.1	3175	40.0	90

4 mm shank

Item no.	D1 (mm)	D2 (mm)	L1 (mm)	α (°)
0068270	0.1	4.0	40.0	20
0068273	0.1	4.0	40.0	30
0068274	0.1	4.0	40.0	40
0068276	0.1	4.0	40.0	60
0068277	0.1	4.0	40.0	90

6 mm shank

Item no.	D1 (mm)	D2 (mm)	L1 (mm)	α (°)
0068284B	0.05	6.0	50.0	20
0068284C	0.1	6.0	50.0	20
0068283	0.1	6.0	50.0	30
0068283L	0.1	6.0	50.0	40
0068285	0.1	6.0	50.0	50
0068285A	0.1	6.0	50.0	60
0068286	0.1	6.0	50.0	90
0068287	0.1	6.0	50.0	120
0068284D	0.2	6.0	50.0	20
0068283D	0.2	6.0	50.0	30
0068285D	0.2	6.0	50.0	60
0068283E	0.3	6.0	50.0	30
0068285E	0.3	6.0	50.0	60
0068284F	0.4	6.0	50.0	20
0068283F	0.4	6.0	50.0	30
0068285F	0.4	6.0	50.0	60
0068283G	0.6	6.0	50.0	30
0068288	6.0	6.0	50.0	180

DATRON

Standard engraving tool balanced

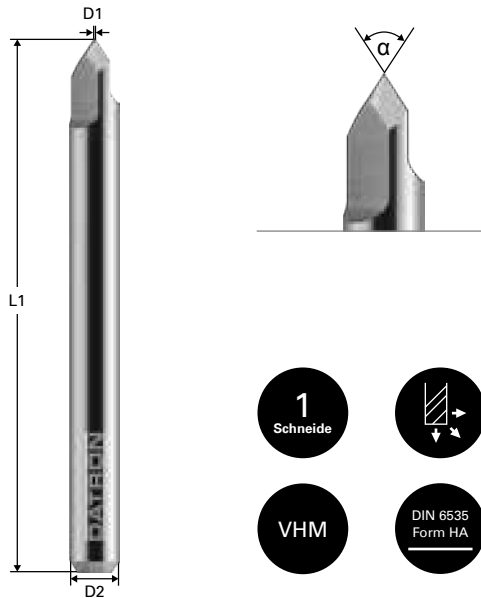

Aluminium



Copper



Bronze



Brass



Plastic



Wood



Acrylic glass



6 mm shank

Item no.	D1 (mm)	D2 (mm)	L1 (mm)	α (°)
0068282G	0.1	6.0	50.0	30
0068284G	0.1	6.0	50.0	40
0068285G	0.1	6.0	50.0	60
0068286G	0.1	6.0	50.0	90

Standard engraving tool for machining steel

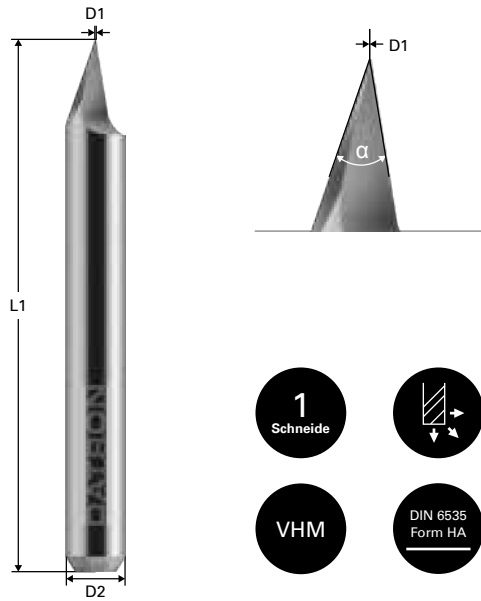

Steel



6 mm shank

Item no.	D1 (mm)	D2 (mm)	L1 (mm)	α (°)
0068510	0.1	6.0	50.0	20
0068511	0.1	6.0	50.0	30
0068512	0.1	6.0	50.0	40
0068513	0.1	6.0	50.0	60
0068514	0.1	6.0	50.0	90
0068510A	0.2	6.0	50.0	20
0068511A	0.2	6.0	50.0	30
0068512A	0.2	6.0	50.0	40
0068513A	0.2	6.0	50.0	60
0068514A	0.2	6.0	50.0	90

DATRON

Standard engraving tool for hard machining with coating (ALCRONA)

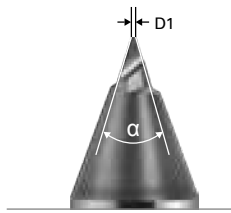
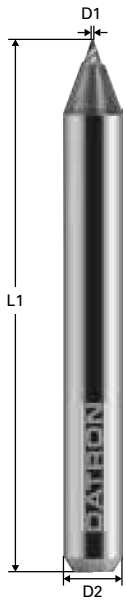

Steel



Bronze



GRP/CRP



4 mm shank

Item no.	D1 (mm)	D2 (mm)	L1 (mm)	α (°)
0068520	0.1	4.0	40.0	30
0068521	0.1	4.0	40.0	45
0068520A	0.2	4.0	40.0	30
0068521A	0.2	4.0	40.0	45

DATRON

T-slotting mill

T-slotting mill

96



DATRON

T-slotting mill



Aluminium

Wood



Bronze

Plastic

Brass

Item no.	D1 (mm)	D2 (mm)	D3 (mm)	L1 (mm)	L2 (mm)	L3 (mm)	Number of flutes
0068425	3.0	3.0	1.6	40.0	0.8	6.0	2
0068424D	6.0	6.0	3.0	50.0	2.8	8.0	4
0068424L	8.0	6.0	3.5	50.0	0.7	6.0	4
0068424K	8.0	6.0	3.5	50.0	1.0	6.0	4
0068424	8.0	6.0	3.5	50.0	1.3	6.0	4
0068424S	8.0	6.0	3.5	50.0	4.5	9.0	4
0068423	10.0	6.0	4.0	50.0	2.0	12.0	4
0068423A	10.0	6.0	4.0	50.0	2.0	12.0	6
0068426	15.0	6.0	6.0	50.0	3.0	25.0	4
0068424A	8.0	8.0	3.5	50.0	1.3	6.0	4

DATRON NEO

Item no.	D1 (mm)	D2 (mm)	D3 (mm)	L1 (mm)	L2 (mm)	L3 (mm)	Number of flutes
0068424A	8	8	3.5	50	1.3	60	4
0068423N	10	8	4	50	2	12	4

DATRON

Cutting diamond

Cutting diamond

98



DATRON

Cutting diamond

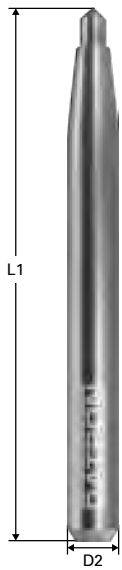

Aluminium



Copper



Bronze



Brass



Wood



Acrylic glass



Plastic



Item no.	D1 (mm)	D2 (mm)	L1 (mm)	α (°)
0068501	0.1	6	61	90
0068502	0.1	6	61	120

DATRON

Swallow-tail mill

Swallow-tail mill

100



DATRON

Swallow-tail mill

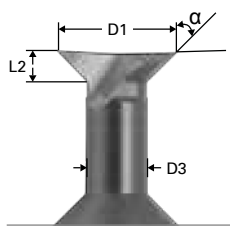
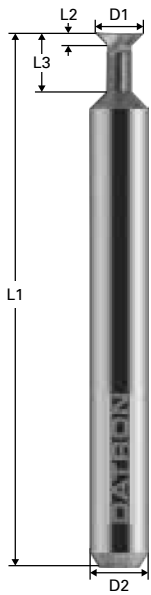

Aluminium



Plastic



Wood



Bronze



Brass



Item no.	D1 (mm)	D2 (mm)	D3 (mm)	L1 (mm)	L2 (mm)	L3 (mm)	α (°)
0068290	3.0	3.0	2.0	40.0	3.0	6.0	5
0068783	3.0	3.0	2.0	40.0	0.87	6.0	30
0068783A	3.0	3.0	2.0	40.0	0.5	6.0	45
0068783B	3.0	3.0	2.0	40.0	0.29	6.0	60
0068690	3175	3175	2.0	39.0	3.0	6.0	5
0068784	4.0	6.0	2.0	50.0	1.73	6.0	30
0068784A	4.0	6.0	2.0	50.0	1.0	6.0	45
0068784B	4.0	6.0	2.0	50.0	0.58	6.0	60
0068785	5.0	6.0	2.5	50.0	2.17	6.0	30
0068785A	5.0	6.0	2.5	50.0	1.25	6.0	45
0068785B	5.0	6.0	2.5	50.0	0.72	6.0	60
0068291	6.0	6.0	5.0	50.0	6.0	6.0	5
0068786	6.0	6.0	3.0	50.0	2.6	6.0	30
0068786A	6.0	6.0	3.0	50.0	1.5	6.0	45
0068786B	6.0	6.0	3.0	50.0	0.87	6.0	60

Tool clamping technique

HSK clamping system

Polygon clamping technique	102
HSK-E 25 & HSK-E 32 polygon clamping chuck	103
DATRON clamping system for polygon clamping chuck	104
DATRON reducing inserts for polygon clamping chuck	104
DATRON DR 16 collet chuck holder for HSK-E 32	105
DATRON mounting accessories for DR 16 collet chuck holder	105

Direct clamping system

Adapter collets for direct shank clamping systems	106
DATRON insertion tools and limit stop rings	106

DATRON

Polygon clamping chuck

The HSK-E polygon chucks have been designed for precise and secure machining, including at high speeds.

The stable, rotationally symmetrical design has an outstanding concentricity of $<3 \mu\text{m}$. This enables high-quality milling results at up to 48,000 rpm.

Passive vibration damping significantly improves the service life of high-frequency spindles and machining tools.



Functional principle of polygon clamping chucks

Clamping diameter similar to polygon shape

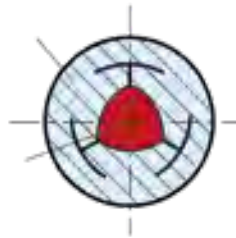

1. Before clamping

The polygon geometry of the shank seat is clear in the unclamped state.

Clamping diameter becomes circular

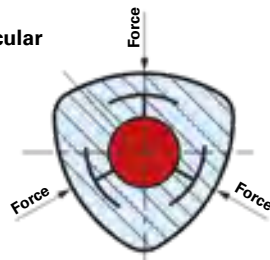

2. In the clamping fixture

Force is applied at three points by the hydraulic clamping fixture. The shank seat becomes circular.

Inserting shank

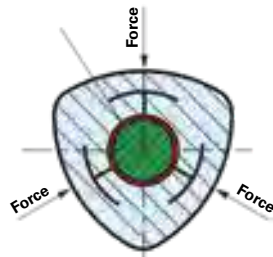

3. Insertion of the tool shank

The tool shank can now be quickly and easily inserted into the seat.

Clamping diameter shrinks

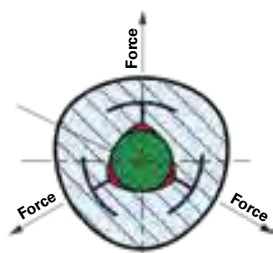

4. The tool is clamped.

The pressure of the clamping fixture is reduced and the force application released. The elastically shaped chuck returns to its polygon shape. The tool is now securely and centrally clamped.

HSK-E 25 & HSK-E 32 polygon clamping chuck



The DATRON polygon clamping chuck are noted for their solid design and a concentricity of <math><3\mu\text{m}</math>. These characteristics ensure highly accurate results for machining.



HSK-E-25

Item no.	D1 (mm)	D2 (mm)	D3 (mm)	L1 (mm)	L2 (mm)
0068300G	3	20	HSK-E-25	40	30
0068300S	3	14	HSK-E-25	40	30
0068311D	3.175	20	HSK-E-25	40	30
0068301G	4	20	HSK-E-25	40	30
0068302G	5	20	HSK-E-25	40	30
0068303G	6	20	HSK-E-25	40	30
0068303S	6	14	HSK-E-25	40	30
0068304G	8	20	HSK-E-25	40	30
0068305G	10	20	HSK-E-25	40	30

HSK-E-32

Item no.	D1 (mm)	D2 (mm)	D3 (mm)	L1 (mm)	L2 (mm)
00580030	3	25	HSK-E-32	55.0	35.0
00580317	3.175	25	HSK-E-32	55.0	35.0
00580040	4	25	HSK-E-32	55.0	35.0
00580050	5	25	HSK-E-32	55.0	35.0
00580060	6	25	HSK-E-32	55.0	35.0
00580080	8	25	HSK-E-32	55.0	35.0
00580100	10	25	HSK-E-32	55.0	35.0
00580120	12	25	HSK-E-32	55.0	35.0

HSK-E-32 with internal cooling

Item no.	D1 (mm)	D2 (mm)	D3 (mm)	L1 (mm)	L2 (mm)
00580030I	3	25	HSK-E-32	55.0	35.0
00580317I	3.175	25	HSK-E-32	55.0	35.0
00580040I	4	25	HSK-E-32	55.0	35.0
00580050I	5	25	HSK-E-32	55.0	35.0
00580060I	6	25	HSK-E-32	55.0	35.0
00580080I	8	25	HSK-E-32	55.0	35.0
00580100I	10	25	HSK-E-32	55.0	35.0
00580120I	12	25	HSK-E-32	55.0	35.0

Accessories

Item no.	Item description
0068353	HSK-32 coolant dispenser pipe
0068353A	HSK-32 key for coolant pipe

DATRON

Clamping fixture for polygon clamping chuck

The hydraulic clamping fixture for polygon clamping chuck, fitted with hand pump and pressure gauge, does not require a power source, making it a very flexible unit. The clamping process requires only a few movements and is completed in less than 20 seconds.

In contrast to shrink technology, this wear-free process does not require heating or cooling phases.



Item no.	Item description
0068340	For HSK-E 25 & HSK-E 32 seats

DATRON

Reducing inserts for polygon clamping chuck

The reducing inserts enable the use of different polygon chucks on the clamping fixture.

Item no.	Item description	for D2	Adapter type
0068341S	Reducing insert	14	HSK-E 25
0068341D	Reducing insert	20	HSK-E 25
0068341E	Reducing insert	25	HSK-E 32



DATRON

DR 16 collet chuck holder for HSK-E 32

The DATRON DR 16 collet chuck holders have a wide range of applications and are noted for their solid construction. A wide range of precision collet chucks allows the collet chuck holders to be used for very different clamping diameters. The high concentricity of the metal sealing precision collet chucks guarantees a concentricity of <math><3 \mu\text{m}</math> in the entire system, which is many times better than the concentricities of conventional ER 16 clamping systems.



Item no.	D1 (mm)	D2 (mm)	D3 (mm)	L1 (mm)	L2 (mm)	Note
0068321	DR 16	24.0	HSK-E 32	55.0	35.0	DR 16 collet chuck holder with clamping nut and coolant pipe
0068321B	3.0	-	DR 16	-	-	DR 16 precision collet chuck, metal sealing
0068321C	4.0	-	DR 16	-	-	DR 16 precision collet chuck, metal sealing
0068321E	6.0	-	DR 16	-	-	DR 16 precision collet chuck, metal sealing
0068321G	8.0	-	DR 16	-	-	DR 16 precision collet chuck, metal sealing
0068321I	10.0	-	DR 16	-	-	DR 16 precision collet chuck, metal sealing

DATRON

Mounting accessories for DR 16 collet chuck holder

DATRON mounting accessories ensure flexible usage of the collet chuck holders from the DATRON range.

Item no.	Item description	Note
0068322	Tool mounting set for DATRON collet chuck holders	Mounting block, adapter for HSK-E 32, roller wrench, handle bar
0068322A	Tool mounting block for DATRON collet chuck holders	including torque gauge
0068322D	Mounting adapter for DATRON collet chuck holders	Fits HSK-E 32 collet chuck holders
0068322C	Roller wrench for DATRON collet chuck holders	Fits DR 16 clamping nuts, D=24 mm
0068322B	Handle bar for roller wrench	L=280 mm



DATRON

Adapter collets for direct shank clamping systems

The DATRON adapter collets enable the use of different tool shanks in only one spindle collet chuck. The adapters are reusable due to their pre-tension. For the defined opening you will need the adapter insertion tool item no. 0068337D for 6 mm and 8 mm adapters.



Item no.	D1 (mm)	D2 (mm)	D3 (mm)
0068336G	1.0	6.0	7.55
0068336H	1.1	6.0	7.55
0068336J	1.2	6.0	7.55
0068336K	1.3	6.0	7.55
0068336L	1.4	6.0	7.55
0068336M	1.5	6.0	7.55
0068336N	1.6	6.0	7.55
0068336P	1.7	6.0	7.55
0068336Q	1.8	6.0	7.55
0068350	1/8"	6.0	7.55
0068350A	1/8"	6.35	7.55

Item no.	D1 (mm)	D2 (mm)	D3 (mm)
0068350C	1/8"	8.0	10.5
0068336B	2.0	6.0	7.55
0068336A	2.0	8.0	10.5
0068336	3.0	6.0	7.55
0068336C	3.0	8.0	10.5
0068350D	4.0	6.0	7.55
0068336D	4.0	8.0	10.5
0068336R	5.0	8.0	10.5
0068336F	6.0	8.0	10.5
0068337D	Adapter insertion tool for 6 mm and 8 mm collet chucks		

DATRON

Limit stop rings and insertion tools

The limit stop rings are used for fixation of the tool shank in the changing station. We recommend our limit stop ring insertion tool for compressing the rings for the 6 mm and 8 mm shanks.

Item no.	D1 (mm)	D2 (mm)	Material	Stop ring insertion tool
0068000	3.0	7.55	Plastic	Fits changing station 0069220
0068000Y	4.0	10.50	Brass	Fits changing station 0069221
0068001	3175	7.55	Plastic	Fits changing station 0069220
0068002	6.0	10.50	Brass	Fits changing station 0069221
0068002A	6.0	12.50	Brass	Fits changing station 0069227
0068002H	6.0	15.00	Brass	Fits changing station 0069223
0068002J	6.0	18.00	Brass	Fits changing station 0069227
0068002Z	6.35	10.50	Brass	Fits changing station 0069221
0068001D	8.0	12.50	Brass	Fits changing station 0069222
0068002K	8.0	18.00	Brass	Fits changing station 0069227
0068180	Limit stop ring insertion tool for 6 mm shank tools			
0068180A	Limit stop ring insertion tool for 8 mm shank tools			



DATRON

Consumable material

VacuCard	108
----------	-----

Cooling lubricants	110
--------------------	-----

DATRON

VacuCard

This cardboard is used as a sacrificial layer with the vacuum clamping technique. The special fabric structure is homogeneously distributed and thus guarantees consistent suction force over the entire clamping area.

- generates homogenous vacuum distribution
- evenly distributed suction force
- Formats match to DATRON vacuum plates



Item no.	Item name	Number of units per VPE	Size (mm)
0A01616*	VacuCard	50	450 x 650 x 0.7
0A01616L**	VacuCard	500	450 x 650 x 0.7
0A01617*	VacuCard	50	500 x 1000 x 0.7
0A01617L**	VacuCard	500	500 x 1000 x 0.7
0A01617A*	VacuCard	50	700 x 1000 x 0.7
0A01617X**	VacuCard	500	700 x 1000 x 0.7

DATRON neo

Item no.	Item name	Number of units per VPE	Size (mm)
0A01617I*	VacuCard (neo)	50	500 x 200 x 0.7
0A01617K*	VacuCard (neo)	50	500 x 400 x 0.7

* from 4 VPE transport will be charged

** plus transport charges

DATRON

VacuCard++ overcomes the physics

Clamp small parts with vacuum

What is the VacuCard++?

VacuCard++ is a special type of cardboard, which DATRON has submitted for patent, which is used as a sacrificial layer between the work piece and the vacuum plate. In contrast to the DATRON VacuCard, it has an additional grid-shaped sealing glue layer that significantly improves the retention properties with vacuum clamping and greatly reduces loss of vacuum.

For what is VacuCard++ suitable?

- Milling machining of small parts from sheet material
- Pattern machining without separating bars
- Milling machining of thin and soft sheet material
- Milling machining of sheet material with rough surface finish

How does the VacuCard++ work?

- The sealing glue layer holds parts that are too small to be retained by the vacuum alone.

- Increases the retention forces in vacuum clamping by a suction cup effect
- Prevents slippage of work pieces under high milling forces
- Reduces vacuum consumption and prevents premature collapse
- The vacuum is evenly distributed over the work piece.
- Prevents edges of soft and flexible work pieces from lifting
- Machined work pieces can be removed without residues

Technical data

- Cardboard with redundant suction cup effect due to grid-shaped sealing glue layer
- Combination of adhesion and vacuum clamping
- Reduced vacuum consumption due to restricted air permeability and coverage with protective foil
- Disposal with paper waste
- Shelf life depends on storage

The patented VacuCard++ is based on the standard VacuCard and has a grid-shaped glue structure. The special glue layer gives the VacuCard++ a significantly higher clamping force and fixed even small light components securely throughout the process.

- grid-shaped glue layer (10 mm x 10 mm)
- secure clamping of delicate components
- homogenous vacuum distribution
- Formats match DATRON vacuum plates

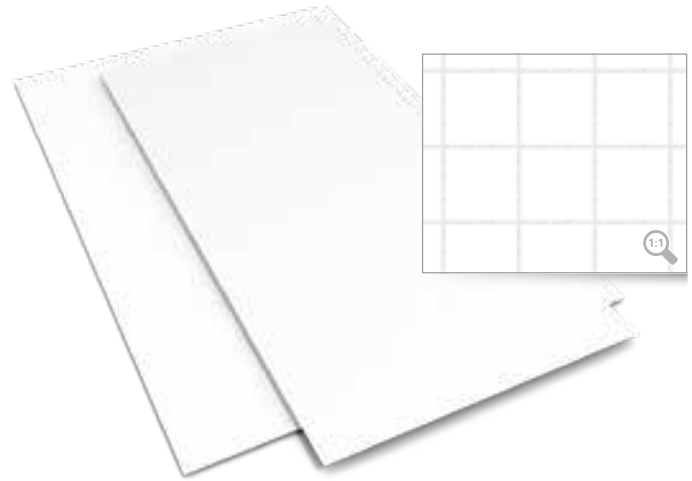

Item no.	Item name	Number of units per VPE	Size (mm)
0A01618G*	VacuCard	10	450 x 650 x 0.7
0A01618D*	VacuCard	50	450 x 650 x 0.7
0A01618H*	VacuCard	10	500 x 1000 x 0.7
0A01618E*	VacuCard	50	500 x 1000 x 0.7
0A01618I*	VacuCard	10	700 x 1000 x 0.7
0A01618F*	VacuCard	50	700 x 1000 x 0.7

* from 4 VPE transport will be charged

DATRON

VacuCard+++

DATRON VacuCard+++

The patented VacuCard+++ is based on the standard VacuCard and has a 5 mm by 5 mm grid-shaped glue structure. The special glue layer gives the VacuCard+++ a significantly higher clamping force and fixed even small light components up to a diameter of 10 mm securely throughout the process.

- grid-shaped glue layer (5 mm x 5 mm)
- secure clamping of very small components
- homogenous vacuum distribution
- Formats match DATRON vacuum plates

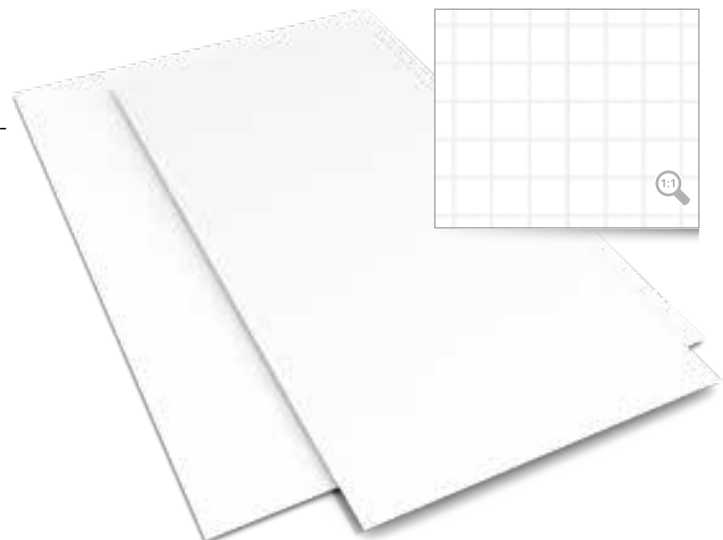

Item no.	Item name	Number of units per VPE	Size (mm)
0A01618M*	VacuCard+++	10	500 x 1000 x 0.7
0A01618K**	VacuCard+++	100	500 x 1000 x 0.7
0A01618N*	VacuCard+++	10	700 x 1000 x 0.7
0A01618L*	VacuCard+++	50	700 x 1000 x 0.7

DATRON *neo*

Item no.	Item name	Number of units per VPE	Size (mm)
0A01618W*	VacuCard+++ (neo)	20	500 x 400 x 0.7

* from 4 VPE transport will be charged

** plus transport charges

DATRON

Cooling lubricants for minimum-quantity lubrication

In addition to CNC machines and tools DATRON now offers matching cooling lubricants. The new cooling lubricants, sold under the name ProCut, are suitable exclusively for minimum-quantity lubrication. The price per litre reflects the very low consumption. There are also significant savings in operating and personnel expenses for cleaning machines and parts and also in changing lubricants. In addition to ProCut cooling lubricants, DATRON offers the Microjet MMS systems, which ensure optimal coverage of the work pieces with their easily aligned spray nozzles.



Item no.

Litres
(per container size)

0069266

10

DATRON ProCut 56

ProCut 56 is a pure hydrocarbon intended as a substitute for ethanol and is ideal for machining aluminium and plastic work pieces – particularly in combination with the DATRON CleanCut chip suction system. The lubricant allows burr-free machining of work pieces. It also prevents material deposition (accumulation on flutes) on the tool. ProCut 56 can be suctioned, is completely volatile and leaves no residues on the work piece. This MM lubricant is ideal for companies or company divisions in which the use of ethanol is prohibited and for machining materials which would react aggressively in contact with ethanol. Cleaning after machining is not required with this lubricant.

consumption without CleanCut: **80 ml/hour**

(approx. 30% of ethanol consumption)

consumption with CleanCut: **270 ml/hour**



Item no.

Litres
(per container size)

0069266A

10

DATRON ProCut 56-2

ProCut 56-2 is a hydrocarbon with minor lubricating constituents and is also an ethanol substitute. It is specially designed for machining Plexiglas or materials with a high surface finish. This MM lubricant is ideal for companies or company divisions in which the use of ethanol is prohibited and for machining materials for a high surface finish is required. Cleaning after machining is required with this lubricant.

consumption without CleanCut: **95 ml/hour**

consumption with CleanCut: **200 ml/hour**



DATRON ProCut 200

The ProCut 200 lubricant can be specially developed for machining steel. This very durable MM lubricant will significantly increase the service life of tools for machining hard materials. Cleaning after machining is required with this lubricant.

consumption: **20ml/hour**

Item no.	Litres (per container size)
0069266D	5
0069266B	10

General information

Tool technology	114
Coatings	115
Guide values for speed and feed	116
Competence CenterTools	117
Customised tools	117

DATRON

Tool technology



Quality and Precision "Made in Germany":

The manufacture of tools in state-of-the-art fully automatic grinding machines in our ultramodern DATRON Tool Technology grinding plant results in consistently high quality and a very good price-performance ratio. Continuous quality control and testing on our in-house milling machines, including under extreme conditions, guarantee that you will benefit from the outstanding quality and performance of DATRON tools.

- Development
- Testing
- Production
- Drilling from 0.1 mm
- Milling from 0.1 mm
- Thread milling from M1



DATRON technology:

The flute geometry of all DATRON milling tools incorporates DATRON expertise derived from more than 25 years of experience in the field of HSC milling. Continuing development and optimisation guarantee you tools that are state of the art in technology.

- intelligent geometries
- the latest grinding machines
- best carbide



Regrinding service:

It does not always need to be new. Consider sustainability with resources and maintain the original quality of your milling tools with our regrinding service!

Save on storage and capital expenses and maintain high availability of the tools for your production. With direct access to our in-house grinding service DATRON Tool Technology GmbH in Lindenfels you will receive the best reprocessed tools with the convenient DATRON shipping and return process.

nachschleifservice@datron.de



Economy:

Your DATRON tools have a particularly long service life resulting from the application of high-quality carbides in ultra-fine-grain quality. Innovative coatings also improve the performance of our tools.

- maximum machining performance
- maximum service life
- maximum reliability

Coatings

BALINIT® X.CEED coating

hardness and high coating adhesion

Coating properties	
Material	AlTiN
Micro hardness	3300 HV
Frictional value	0.4 (dry against steel)
Max. application temperature	900 °C
Colour	blue-grey



The hardness, oxidation resistance and thermal stability of X.CEED have been optimised for applications in high-speed machining of hard materials. The coating provides protection from abrasion and adhesion throughout the entire cutting speed range even with very solid materials that are difficult to machine. The good frictional properties reduce the cutting forces.

BALINIT® ALCRONA coating

low frictional value and heat hardness

Coating properties	
Material	AlCrN
Micro hardness	3200 HV
Frictional value	0.35 (dry against steel)
Max. application temperature	1100°C
Colour	light grey



Excellent wear resistance, thermal shock stability and heat hardness – these are the properties that have been extensively modified to improve the proven ALCRONA coating even more. The performance profile of the new coating has been significantly improved by optimisation of the process parameters and modification of the coating structure. ALCRONA is the new top all-rounder in machining.

BALINIT® ALNOVA coating

high thermal shock stability, good chip removal

Coating properties	
Material	AlCrN-based
Micro hardness	3200 HV
Frictional value	0.3 (dry against steel)
Max. application temperature	>1100 °C
Colour	light grey



BALINIT® ALNOVA is characterised particularly by optimal coating adhesion, high thermal shock stability, good chip removal and extremely high tool stability at the cutting edges. The extremely durable and smooth surface finish of the coating makes it ideal for tools exposed to very high temperatures during machining.

Diamond coating

high hardness and chemical resistance

Coating properties	
Material	Diamond
Micro hardness	10000 HV
Frictional value	0.4 (dry against steel)
Max. application temperature	700°C
Colour	dark grey



The unique material properties of multi-layer diamond coatings offer significant performance potential, particularly for machining graphite and hard metal and ceramic blanks. These types of highly abrasive materials can be machined very economically today with precisely designed CVD diamond coatings on carbide.

DATRON

Guide values for speed and feed

Formulas for calculating the milling parameters

Formula	Parameters
<p>Cutting speed</p> $V_c = \frac{\pi * d * n}{1000}$	<p>V_c = cutting speed (mm/min) d = tool diameter (mm) n = speed (rpm)</p>
<p>Cutting speed</p> $V_f = f_z * n * z$	<p>v_f = cutting speed (mm/min) f_z = tooth feed (mm/min) n = speed (rpm) z = tooth number (-)</p>
<p>cutting capacity</p> $P_c = \frac{Q}{V_{sp}}$	<p>P_c = cutting capacity (kW) Q = chip volume per unit time (cm³/min) V_{sp} = spec. chip volume per unit time (cm³/min/kW)</p>
<p>Chip volume</p> $Q = a_e * a_p * v_f$	<p>Q = chip volume per unit time (cm³/min) a_e = radial working engagement (mm) a_p = cutting depth (mm) v_f = cutting speed (mm/min)</p>

Machining of plastics

When machining plastics, such as duroplasts and thermo-plasts, generally select lower speeds and higher feeds as compared to aluminium.

Engraving with engraving tools

Select the following values for engraving aluminium or brass with a graver:
 Speed approx. 30,000 rpm
 Feed approx. 0.7 m/min

Competence Center Tools

We have set up the DATRON Competence Center Tools (CCT) to provide customised consulting for your tool needs. This team of specialists is your first port of call and the central contact for all technical tool questions.

Customised tools

Do you need a special tool? Not a problem for DATRON!

DATRON manufactures customised tools to your specifications for your applications. The tools are made from your drawings and specifications to the highest DATRON quality on our state of the art automatic grinding machines. Some examples of what we can supply are step mills, step drills, special shapes and micro-tools.

Simply input the required characteristics into the table below and send it to us by fax or email.

Fax to: +49 (0)6151-14 19-29

Email to: cct@datron.de

Designation	Your individual data
Milling tool comparable with item number	Item no.:
D1 flute diameter	
D2 shank diameter	
D3 toric cut diameter	
L1 total length*	
L2 flute length	
L3 toric cut usable length	
R radius	
BS coating	

*The total length L1 may vary

Remarks

